

WERKZEUGTECHNIK

BENZ SELECT LINE

BLP-EDITION

Winkelköpfe Typ
WSX MONO &
WWX FORTE
inklusive Adapter
und Stopblock



BLP-EDITION



TLP-EDITION

WINKELKÖPFE

BENZ Qualität • Attraktive Preise • Schnelle Lieferung

BENZ SELECT LINE - BLP-EDITION: PRODUKTPROGRAMM

TYP WSX MONO

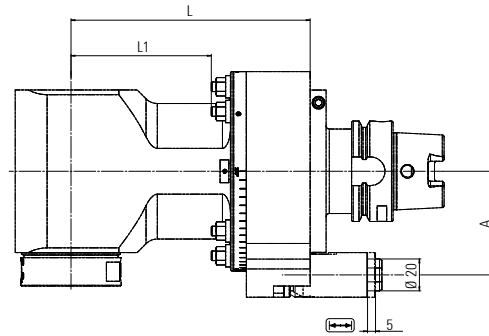

- Darstellung zeigt ein Konfigurationsbeispiel
- Antriebskegel verfügbar als HSK-A63, HSK-A100, SK40, SK50, BT40, BT50, CAT40 und CAT50
- Gefederte Arretierhülse mit 5 mm Hub
- Informationen zur TLP-Edition, erhalten Sie über unser Benz Sales Team.

Technische Daten

TYP	Werkzeugspindel	Winkelkopf	Antriebskegel	L [mm]	L ₁	A [mm]	i	n [min ⁻¹]	M [Nm]	Kühlung - EK/IK	Bestellnummer
WSX Mono Größe 05	S3 x ER25	05	HSK-A63	135	76	65	1	8000	30	●	771WSX00205S3-135SLT
	S3 x ER25	05	HSK-A63	135	76	80	1	8000	30	●	771WSX00405S3-135SLT
	S3 x ER25	05	HSK-A100	135	76	80	1	8000	30	●	772WSX00205S3-135SLT
	S3 x ER25	05	HSK-A100	135	76	110	1	8000	30	●	772WSX00405S3-135SLT
	S3 x ER25	05	SK40	135	76	65	1	8000	30	●	040WSX00205S3-135SLT
	S3 x ER25	05	SK40	135	76	80	1	8000	30	●	040WSX00405S3-135SLT
	S3 x ER25	05	SK50	135	76	80	1	8000	30	●	042WSX00205S3-135SLT
	S3 x ER25	05	SK50	135	76	110	1	8000	30	●	042WSX00405S3-135SLT
	S3 x ER25	05	BT40	135	76	65	1	8000	30	●	039WSX00205S3-135SLT
	S3 x ER25	05	BT40	135	76	80	1	8000	30	●	039WSX00405S3-135SLT
	S3 x ER25	05	BT50	135	76	80	1	8000	30	●	011WSX00205S3-135SLT
	S3 x ER25	05	BT50	135	76	110	1	8000	30	●	011WSX00405S3-135SLT
	S3 x ER25	05	CAT40	135	76	65	1	8000	30	●	377WSX00205S3-135SLT
	S3 x ER25	05	CAT40	135	76	80	1	8000	30	●	377WSX00405S3-135SLT
	S3 x ER25	05	CAT50	135	76	80	1	8000	30	●	107WSX00205S3-135SLT
	S3 x ER25	05	CAT50	135	76	110	1	8000	30	●	107WSX00405S3-135SLT
WSX Mono Größe 07	S4 x ER32	07	HSK-A63	150	88	65	1	6000	70	●	771WSX00207S4-150SLT
	S4 x ER32	07	HSK-A63	150	88	80	1	6000	70	●	771WSX00407S4-150SLT
	S4 x ER32	07	HSK-A100	150	88	80	1	6000	70	●	772WSX00207S4-150SLT
	S4 x ER32	07	HSK-A100	150	88	110	1	6000	70	●	772WSX00407S4-150SLT
	S4 x ER32	07	SK40	150	88	65	1	6000	70	●	040WSX00207S4-150SLT
	S4 x ER32	07	SK40	150	88	80	1	6000	70	●	040WSX00407S4-150SLT
	S4 x ER32	07	SK50	150	88	80	1	6000	70	●	042WSX00207S4-150SLT
	S4 x ER32	07	SK50	150	88	110	1	6000	70	●	042WSX00407S4-150SLT
	S4 x ER32	07	BT40	150	88	65	1	6000	70	●	039WSX00207S4-150SLT
	S4 x ER32	07	BT40	150	88	80	1	6000	70	●	039WSX00407S4-150SLT
	S4 x ER32	07	BT50	150	88	80	1	6000	70	●	011WSX00207S4-150SLT
	S4 x ER32	07	BT50	150	88	110	1	6000	70	●	011WSX00407S4-150SLT
	S4 x ER32	07	CAT40	150	88	65	1	6000	70	●	377WSX00207S4-150SLT
	S4 x ER32	07	CAT40	150	88	80	1	6000	70	●	377WSX00407S4-150SLT
	S4 x ER32	07	CAT50	150	88	80	1	6000	70	●	107WSX00207S4-150SLT
	S4 x ER32	07	CAT50	150	88	110	1	6000	70	●	107WSX00407S4-150SLT

Lieferumfang: Winkelkopf mit modularem Schnellwechselsystem BENZ Solidfix® inklusive 1 Adapter (Typ ER Spannzange) und 1 Stoppblock

BENZ SELECT LINE - BLP-EDITION: PRODUKTPROGRAMM

TYP WWX FORTE

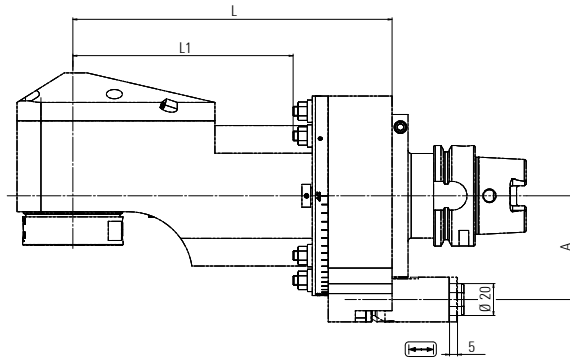

- Darstellung zeigt ein Konfigurationsbeispiel
- Antriebskegel verfügbar als HSK-A63, HSK-A100, SK40, SK50, BT40, BT50, CAT40 und CAT50
- Gefederte Arretierhülse mit 5 mm Hub
- Informationen zur TLP-Edition, erhalten Sie über unser Benz Sales Team.

Technische Daten

TYP	Werkzeugspindel	Winkelkopf	Antriebskegel	L [mm]	L ₁	A [mm]	i	n [min ⁻¹]	M [Nm]	Kühlung - EK/IK	Bestellnummer
WWX Forte Größe 05	S3 x ER25	05	HSK-A63	172	113	65	1	8000	30	●	771WWX00205S3-172SLT
	S3 x ER25	05	HSK-A63	172	113	65	1	8000	30	●	711WWX00205S3-172SLT
	S3 x ER25	05	HSK-A63	172	113	80	1	8000	30	●	771WWX00405S3-172SLT
	S3 x ER25	05	HSK-A63	172	113	80	1	8000	30	●	711WWX00405S3-172SLT
	S3 x ER25	05	HSK-A100	172	113	80	1	8000	30	●	772WWX00205S3-172SLT
	S3 x ER25	05	HSK-A100	172	113	80	1	8000	30	●	713WWX00205S3-172SLT
	S3 x ER25	05	HSK-A100	172	113	110	1	8000	30	●	772WWX00405S3-172SLT
	S3 x ER25	05	HSK-A100	172	113	110	1	8000	30	●	713WWX00405S3-172SLT
	S3 x ER25	05	SK40	172	113	65	1	8000	30	●	040WWX00205S3-172SLT
	S3 x ER25	05	SK40	172	113	65	1	8000	30	●	240WWX00205S3-172SLT
	S3 x ER25	05	SK40	172	113	80	1	8000	30	●	040WWX00405S3-172SLT
	S3 x ER25	05	SK40	172	113	80	1	8000	30	●	240WWX00405S3-172SLT
	S3 x ER25	05	SK50	172	113	80	1	8000	30	●	042WWX00205S3-172SLT
	S3 x ER25	05	SK50	172	113	80	1	8000	30	●	242WWX00205S3-172SLT
	S3 x ER25	05	SK50	172	113	110	1	8000	30	●	042WWX00405S3-172SLT
	S3 x ER25	05	SK50	172	113	110	1	8000	30	●	242WWX00405S3-172SLT
	S3 x ER25	05	BT40	172	113	65	1	8000	30	●	039WWX00205S3-172SLT
	S3 x ER25	05	BT40	172	113	65	1	8000	30	●	339WWX00205S3-172SLT
	S3 x ER25	05	BT40	172	113	80	1	8000	30	●	039WWX00405S3-172SLT
	S3 x ER25	05	BT40	172	113	80	1	8000	30	●	339WWX00405S3-172SLT
	S3 x ER25	05	BT50	172	113	80	1	8000	30	●	011WWX00205S3-172SLT
	S3 x ER25	05	BT50	172	113	80	1	8000	30	●	466WWX00205S3-172SLT
	S3 x ER25	05	BT50	172	113	110	1	8000	30	●	011WWX00405S3-172SLT
	S3 x ER25	05	BT50	172	113	110	1	8000	30	●	466WWX00405S3-172SLT
	S3 x ER25	05	CAT40	172	113	65	1	8000	30	●	377WWX00205S3-172SLT
	S3 x ER25	05	CAT40	172	113	65	1	8000	30	●	378WWX00205S3-172SLT
	S3 x ER25	05	CAT40	172	113	80	1	8000	30	●	377WWX00405S3-172SLT
	S3 x ER25	05	CAT40	172	113	80	1	8000	30	●	378WWX00405S3-172SLT
	S3 x ER25	05	CAT50	172	113	80	1	8000	30	●	107WWX00205S3-172SLT
	S3 x ER25	05	CAT50	172	113	80	1	8000	30	●	354WWX00205S3-172SLT
	S3 x ER25	05	CAT50	172	113	110	1	8000	30	●	107WWX00405S3-172SLT
	S3 x ER25	05	CAT50	172	113	110	1	8000	30	●	534WWX00405S3-172SLT

Lieferumfang: Winkelkopf mit modularem Schnellwechselsystem BENZ Solidfix® inklusive 1 Adapter (Typ ER Spannzange) und 1 Stopblock

BENZ SELECT LINE - BLP-EDITION: PRODUKTPROGRAMM

Technische Daten

TYP	Werkzeug-spindel	Winkel-kopf	Antriebs-kegel	L [mm]	L ₁	A [mm]	i	n [min ⁻¹]	M [Nm]	Kühlung - EK/IK	Bestellnummer
WWX Forte Größe 07	S4 x ER32	07	HSK-A63	200	138	65	1	6000	70	●	771WWX00207S4-200SLT
	S4 x ER32	07	HSK-A63	200	138	65	1	6000	70	●	711WWX00207S4-200SLT
	S4 x ER32	07	HSK-A63	200	138	80	1	6000	70	●	771WWX00407S4-200SLT
	S4 x ER32	07	HSK-A63	200	138	80	1	6000	70	●	711WWX00407S4-200SLT
	S4 x ER32	07	HSK-A100	200	138	80	1	6000	70	●	772WWX00207S4-200SLT
	S4 x ER32	07	HSK-A100	200	138	80	1	6000	70	●	713WWX00207S4-200SLT
	S4 x ER32	07	HSK-A100	200	138	110	1	6000	70	●	772WWX00407S4-200SLT
	S4 x ER32	07	HSK-A100	200	138	110	1	6000	70	●	713WWX00407S4-200SLT
	S4 x ER32	07	SK40	200	138	65	1	6000	70	●	040WWX00207S4-200SLT
	S4 x ER32	07	SK40	200	138	65	1	6000	70	●	240WWX00207S4-200SLT
	S4 x ER32	07	SK40	200	138	80	1	6000	70	●	040WWX00407S4-200SLT
	S4 x ER32	07	SK40	200	138	80	1	6000	70	●	240WWX00407S4-200SLT
	S4 x ER32	07	SK50	200	138	80	1	6000	70	●	042WWX00207S4-200SLT
	S4 x ER32	07	SK50	200	138	80	1	6000	70	●	242WWX00207S4-200SLT
	S4 x ER32	07	SK50	200	138	110	1	6000	70	●	042WWX00407S4-200SLT
	S4 x ER32	07	SK50	200	138	110	1	6000	70	●	242WWX00407S4-200SLT
	S4 x ER32	07	BT40	200	138	65	1	6000	70	●	039WWX00207S4-200SLT
	S4 x ER32	07	BT40	200	138	65	1	6000	70	●	339WWX00207S4-200SLT
	S4 x ER32	07	BT40	200	138	80	1	6000	70	●	039WWX00407S4-200SLT
	S4 x ER32	07	BT40	200	138	80	1	6000	70	●	339WWX00407S4-200SLT
	S4 x ER32	07	BT50	200	138	80	1	6000	70	●	011WWX00207S4-200SLT
	S4 x ER32	07	BT50	200	138	80	1	6000	70	●	466WWX00207S4-200SLT
	S4 x ER32	07	BT50	200	138	110	1	6000	70	●	011WWX00407S4-200SLT
	S4 x ER32	07	BT50	200	138	110	1	6000	70	●	466WWX00407S4-200SLT
	S4 x ER32	07	CAT40	200	138	65	1	6000	70	●	377WWX00207S4-200SLT
	S4 x ER32	07	CAT40	200	138	65	1	6000	70	●	378WWX00207S4-200SLT
	S4 x ER32	07	CAT40	200	138	80	1	6000	70	●	377WWX00407S4-200SLT
	S4 x ER32	07	CAT40	200	138	80	1	6000	70	●	378WWX00407S4-200SLT
	S4 x ER32	07	CAT50	200	138	80	1	6000	70	●	107WWX00207S4-200SLT
	S4 x ER32	07	CAT50	200	138	80	1	6000	70	●	354WWX00207S4-200SLT
	S4 x ER32	07	CAT50	200	138	110	1	6000	70	●	107WWX00407S4-200SLT
	S4 x ER32	07	CAT50	200	138	110	1	6000	70	●	534WWX00407S4-200SLT





Lieferumfang: Winkelkopf mit modularem Schnellwechselsystem BENZ Solidfix® inklusive 1 Adapter (Typ ER Spannzange) und 1 Stopblock

ZUBEHÖR

TYP	Größe	Bestellnummer
	S3 x ER25	693.130E534
	S4 x ER32	694.130E639

TYP	für A [mm]	Bestellnummer
	A 65	K00600-055/075
	A 80	K00600-070/090
	A 110	K00600-100/120

ZUBEHÖR OPTIONAL

TYP	Größe	Bestellnummer
Starter Set	S3 x ER25	S3-SET-001
	S4 x ER32	S4-SET-001
 Montageblock	 Inbus-schlüssel	
 Haken-schlüssel	 Spann-schlüssel	