

HARTNER

Precision Cutting Tools

MULTIPLEX HPC

DAS WECHSELPLATTEN-BOHRSYSTEM
FÜR BOHRUNGEN BIS 10xD UND BIS DURCHMESSER 40,0 mm

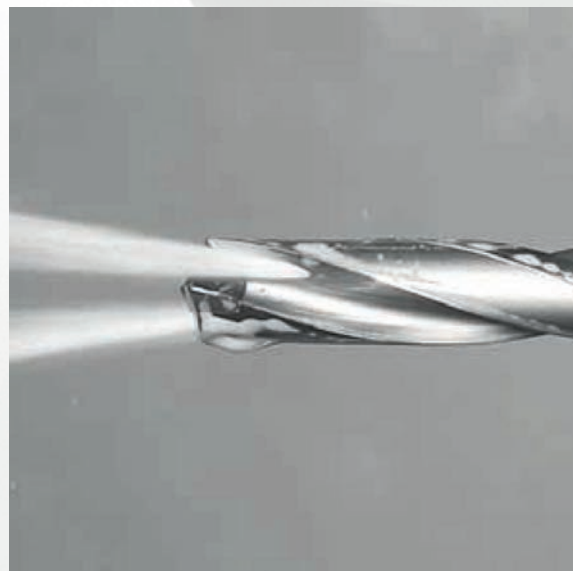

+ neue Wechselplatte für die Stahlträger-Bearbeitung

ISO-Code

P	Stahl, hochlegierter Stahl
M	Rostfreier Stahl
K	Grauguss, Sphäroguss und Temperguss
N	Aluminium und andere Nichteisenmetalle
S	Sonder-, Super- und Titanlegierungen
H	Gehärteter Stahl und Hartguss

Piktogramme

Schneidstoff

VHM

Vollhartmetall

Oberfläche



blank AlTiN nano FIRE TiAlN TiAlSiN ver-nickelt TiN

Typ

HPC

Bohrtiefe



Ø-Toleranz



Norm



nach Hartner Standard

Spitzenwinkel



Schneidrichtung



rechts neutral

Schaftform



nach DIN 6535

Ausspitzung



Innenkühlung



mit IK





MULTIPLEX HPC

- ▼ WECHSELPLATTENHALTER

SEITE 9



MULTIPLEX HPC

- ▼ WECHSELPLATTEN

SEITE 20



MULTIPLEX HPC

- ▼ ZUBEHÖR

SEITE 45

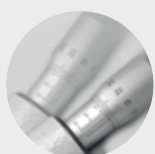

TECHNISCHER TEIL

- ▼ DIE BESCHICHTUNGEN
- ▼ MULTIPLEX HPC – TECHNIK UND VORTEILE
- ▼ FINDEN UND BESEITIGEN VON PROBLEMEN

SEITE 51



EINSATZEMPFEHLUNGEN

SEITE 58

DAS MODULARE WERKZEUGSYSTEM MULTIPLEX HPC

Mit dem Wechselplatten-Bohrsystem Multiplex HPC bietet Hartner leistungsstarke und kostengünstige Halter und Wechselplatten für Bohrungen im Durchmesserbereich von 11,00 bis 40,00 mm an.

Das Multiplex HPC-Bohrsystem ist damit ideal zur Herstellung großer, hochpräziser Bohrungen in unterschiedlichsten Werkstoffen für Anwendungen wie sie z. B. im Bereich Energietechnik, Automobilbau, Maschinenbau oder Stahlbau vorkommen.

hohe Standzeiten

- Wechselplatten hinsichtlich Schneidstoff, Geometrie und Oberfläche perfekt auf jeweiliges Einsatzgebiet abgestimmt
- optimale Bearbeitungsergebnisse in Stahl, rostfreiem Stahl, Guss oder Alu

optimaler Spantransport

- spezieller Nutquerschnitt
- ultraglatte Oberfläche

stabile Halter

- eng gestufte Ø-Sprünge der Haltergrößen reduzieren Verschleiß
- bessere Werkstückoberflächen
- bessere Führung des Werkzeugs erhöht Stabilität
- längere Werkzeuglebensdauer

hochpräziser Plattensitz

- Plattenwechsel innerhalb der Maschine
- Halter bleibt gespannt
- Werkzeugwechsel und Neueinstellung entfallen
- erhöhte Prozesssicherheit und kürzere Rüstzeiten

perfekte Kühlschmierung

- Kühlkanäle mit maximalem Querschnitt
- Austritt aus der Spannut



MULTIPLEX HPC – WECHSELPLATTENHALTER

Für jede Bohrtiefe und jede Anwendung der richtige Halter

Artikel-Nr.	86681	86682	86683	86684	86685	86686
Bohrtiefe	1xD	1,5xD	3xD	5xD	7xD	10xD
Bohr-Ø	11,0-40,00	11,0-40,00	11,0-40,00	11,0-40,00	11,0-31,99	11,0-31,99
Schaftform	DIN 6535-HE	DIN 6535-HE	DIN 6535-HE	DIN 6535-HE	DIN 6535-HE	DIN 6535-HE
Seite	19	9	11	13	15	17



Der Pilothalter Art.-Nr. 86681 ist mit einer Schnittstelle für Senkplatten ausgerüstet. Somit kann bei der Herstellung der Pilotbohrung die Kante gleichzeitig mit 45° gefast werden.

MULTIPLEX HPC – WECHSELPLATTEN

Für jedes Material und jede Anwendung die richtige Wechselplatte

					zum Pilotieren	für Stahlträger
Wechselplatten						
Artikel-Nr.	86722	86725	86723	86724	86721	86729
Seite	20	24	28	32	36	40
Senkplatten						
Artikel-Nr.	86728		86726	86727		
Seite	42		43	44		

P	M	K	N	S	H	Norm	Typ	Schneidstoff	Oberfläche	Schneid- richtung	Innen- kühlung	Bohrtiefe	d1/mm	Artikel-Nr.	Progr. Seite
---	---	---	---	---	---	------	-----	--------------	------------	----------------------	-------------------	-----------	-------	-------------	-----------------

Multiplex HPC-Halter



						Werksnorm	HPC		Ⓝ	rechts	mit	1,5xD	11,000 - 39,005	86682	9
--	--	--	--	--	--	-----------	-----	--	---	--------	-----	-------	-----------------	--------------	---



						Werksnorm	HPC		Ⓝ	rechts	mit	3xD	11,000 - 39,005	86683	11
--	--	--	--	--	--	-----------	-----	--	---	--------	-----	-----	-----------------	--------------	----



						Werksnorm	HPC		Ⓝ	rechts	mit	5xD	11,000 - 39,000	86684	13
--	--	--	--	--	--	-----------	-----	--	---	--------	-----	-----	-----------------	--------------	----



						Werksnorm	HPC		Ⓝ	rechts	mit	7xD	11,000 - 31,505	86685	15
--	--	--	--	--	--	-----------	-----	--	---	--------	-----	-----	-----------------	--------------	----



						Werksnorm	HPC		Ⓝ	rechts	mit	10xD	11,000 - 31,505	86686	17
--	--	--	--	--	--	-----------	-----	--	---	--------	-----	------	-----------------	--------------	----



						Werksnorm			Ⓝ	rechts	mit	1xD	11,000 - 36,005	86681	19
--	--	--	--	--	--	-----------	--	--	---	--------	-----	-----	-----------------	--------------	----

Multiplex HPC-Wechselplatten



●	○	○				Werksnorm	HPC	VHM	Ⓝ	rechts			11,000 - 40,000	86722	20
---	---	---	--	--	--	-----------	-----	------------	---	--------	--	--	-----------------	--------------	----



○	●					Werksnorm	HPC	VHM	Ⓝ	rechts			11,000 - 40,000	86725	24
---	---	--	--	--	--	-----------	-----	------------	---	--------	--	--	-----------------	--------------	----

P	M	K	N	S	H	Norm	Typ	Schneidstoff	Oberfläche	Schneid- richtung	Innen- kühlung	Bohrtiefe	d1/mm	Artikel-Nr.	Progr. Seite
---	---	---	---	---	---	------	-----	--------------	------------	----------------------	-------------------	-----------	-------	-------------	-----------------

Multiplex HPC-Wechselplatten



○	●	○	○	○	○	Werksnorm	HPC	VHM	Ⓜ	rechts		11,000 - 40,000	86723	28
---	---	---	---	---	---	-----------	-----	-----	---	--------	--	-----------------	-------	----



○	○	○	●	○	○	Werksnorm	HPC	VHM	○	rechts		11,000 - 40,000	86724	32
---	---	---	---	---	---	-----------	-----	-----	---	--------	--	-----------------	-------	----



○	○	○	○	○	○	Werksnorm	HPC	VHM	Ⓜ	rechts		11,000 - 40,000	86721	36
---	---	---	---	---	---	-----------	-----	-----	---	--------	--	-----------------	-------	----



●	○	○	○	○	○	Werksnorm		VHM	Ⓜ	rechts		12,000 - 40,000	86729	40
---	---	---	---	---	---	-----------	--	-----	---	--------	--	-----------------	-------	----

Multiplex HPC-Senkplatten



●	○	○	○	○	○	Werksnorm		VHM	Ⓜ	rechts		52,020 - 93,080	86728	42
---	---	---	---	---	---	-----------	--	-----	---	--------	--	-----------------	-------	----



○	○	○	○	○	○	Werksnorm		VHM	Ⓜ	neutral		52,020 - 93,080	86726	43
---	---	---	---	---	---	-----------	--	-----	---	---------	--	-----------------	-------	----



○	○	○	○	○	○	Werksnorm		VHM	○	rechts		52,020 - 93,080	86727	44
---	---	---	---	---	---	-----------	--	-----	---	--------	--	-----------------	-------	----

P	M	K	N	S	H	Norm	Typ	Schneidstoff	Oberfläche	Schneid- richtung	Innen- kühlung	Bohrtiefe	d1/mm	Artikel-Nr.	Progr. Seite
---	---	---	---	---	---	------	-----	--------------	------------	----------------------	-------------------	-----------	-------	-------------	-----------------

Spannschrauben für Multiplex HPC-Senkhalter



Werksnorm

2,000 - 4,006

86846

45

Spannschrauben für Multiplex HPC-Halter 1,5-10xD



Werksnorm

2,200 - 6,002

86843

46

Drehmomentschlüssel



Werksnorm

1,001 - 14,000

86844

47

Torx-Einsätze



Werksnorm

5,000 - 25,001

86845

48

Zubehör



Werksnorm

5,001 - 25,001

86842

49



Multiplex HPC-Halter

Artikel-Nr. 86682



besonders hohe Verschleißfestigkeit • optimierter Nutquerschnitt • optimierter Kühlkanalaustritt • Spanschrauben Art.-Nr. 86843 enthalten • Schraubendreher Art.-Nr. 86842 enthalten

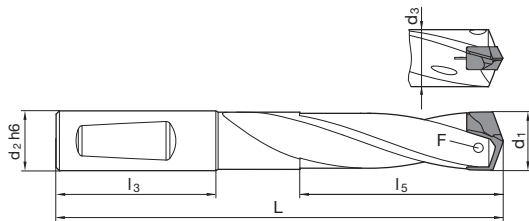

Größe mm	d1	d2 h6 mm	d3 mm	L mm	l3 mm	l5 mm	F	Code-Nr.
110	11,00-11,49	12,000	10,700	84,000	45,000	19,300	86843 2.200	11,000
110	11,00-11,49	12,700	10,700	84,000	45,000	19,300	86843 2.200	11,005
115	11,50-11,99	12,000	11,200	85,000	45,000	20,100	86843 2.200	11,500
115	11,50-11,99	12,700	11,200	85,000	45,000	20,100	86843 2.200	11,505
120	12,00-12,49	12,000	11,700	87,000	45,000	21,000	86843 2.201	12,000
120	12,00-12,49	12,700	11,700	87,000	45,000	21,000	86843 2.201	12,005
125	12,50-12,99	14,000	12,200	89,000	45,000	21,900	86843 2.201	12,500
125	12,50-12,99	15,875	12,200	89,000	45,000	21,900	86843 2.201	12,505
130	13,00-13,49	14,000	12,700	90,000	45,000	22,600	86843 2.500	13,000
130	13,00-13,49	15,875	12,700	90,000	45,000	22,600	86843 2.500	13,005
135	13,50-13,99	14,000	13,200	92,000	45,000	23,600	86843 2.500	13,500
135	13,50-13,99	15,875	13,200	92,000	45,000	23,600	86843 2.500	13,505
140	14,00-14,49	14,000	13,700	93,000	45,000	24,500	86843 3.000	14,000
140	14,00-14,49	15,875	13,700	93,000	45,000	24,500	86843 3.000	14,005
145	14,50-14,99	16,000	14,200	98,000	48,000	25,300	86843 3.000	14,500
145	14,50-14,99	15,875	14,200	98,000	48,000	25,300	86843 3.000	14,505
150	15,00-15,49	16,000	14,700	100,000	48,000	26,100	86843 3.001	15,000
150	15,00-15,49	15,875	14,700	100,000	48,000	26,100	86843 3.001	15,005
155	15,50-15,99	16,000	15,200	101,000	48,000	27,000	86843 3.001	15,500
155	15,50-15,99	15,875	15,200	101,000	48,000	27,000	86843 3.001	15,505
160	16,00-16,49	16,000	15,700	102,000	48,000	27,800	86843 3.500	16,000
160	16,00-16,49	15,875	15,700	102,000	48,000	27,800	86843 3.500	16,005
165	16,50-16,99	18,000	16,200	105,000	48,000	28,700	86843 3.500	16,500
165	16,50-16,99	19,050	16,200	105,000	48,000	28,700	86843 3.500	16,505
170	17,00-17,49	18,000	16,700	106,000	48,000	29,600	86843 3.500	17,000
170	17,00-17,49	19,050	16,700	106,000	48,000	29,600	86843 3.500	17,005
175	17,50-17,99	18,000	17,200	107,000	48,000	30,400	86843 3.500	17,500
175	17,50-17,99	19,050	17,200	107,000	48,000	30,400	86843 3.500	17,505
180	18,00-18,49	18,000	17,700	109,000	48,000	31,200	86843 4.000	18,000
180	18,00-18,49	19,050	17,700	109,000	48,000	31,200	86843 4.000	18,005
185	18,50-18,99	20,000	18,200	113,000	50,000	32,100	86843 4.000	18,500
185	18,50-18,99	19,050	18,200	113,000	50,000	32,100	86843 4.000	18,505
190	19,00-19,49	20,000	18,700	114,000	50,000	32,900	86843 4.000	19,000
190	19,00-19,49	19,050	18,700	114,000	50,000	32,900	86843 4.000	19,005
195	19,50-19,99	20,000	19,200	116,000	50,000	33,700	86843 4.000	19,500
195	19,50-19,99	19,050	19,200	116,000	50,000	33,700	86843 4.000	19,505
200	20,00-20,49	20,000	19,700	117,000	50,000	34,600	86843 4.500	20,000
200	20,00-20,49	19,050	19,700	117,000	50,000	34,600	86843 4.500	20,005
205	20,50-20,99	25,000	20,200	128,000	56,000	35,500	86843 4.500	20,500
205	20,50-20,99	25,400	20,200	128,000	56,000	35,500	86843 4.500	20,505
210	21,00-21,49	25,000	20,700	129,000	56,000	36,400	86843 4.500	21,000
210	21,00-21,49	25,400	20,700	129,000	56,000	36,400	86843 4.500	21,005



Multiplex HPC-Halter

Größe mm	d1	d2 h6 mm	d3 mm	L mm	l3 mm	l5 mm	F	Code-Nr.
215	21,50-21,99	25,000	21,200	130,000	56,000	37,200	86843 4.500	21,500
215	21,50-21,99	25,400	21,200	130,000	56,000	37,200	86843 4.500	21,505
220	22,00-22,49	25,000	21,700	131,000	56,000	38,000	86843 5.000	22,000
220	22,00-22,49	25,400	21,700	131,000	56,000	38,000	86843 5.000	22,005
225	22,50-22,99	25,000	22,200	134,000	56,000	38,900	86843 5.000	22,500
225	22,50-22,99	25,400	22,200	134,000	56,000	38,900	86843 5.000	22,505
230	23,00-23,49	25,000	22,700	135,000	56,000	39,800	86843 5.000	23,000
230	23,00-23,49	25,400	22,700	135,000	56,000	39,800	86843 5.000	23,005
235	23,50-23,99	25,000	23,200	137,000	56,000	40,600	86843 5.000	23,500
235	23,50-23,99	25,400	23,200	137,000	56,000	40,600	86843 5.000	23,505
240	24,00-24,49	25,000	23,700	138,000	56,000	41,500	86843 5.001	24,000
240	24,00-24,49	25,400	23,700	138,000	56,000	41,500	86843 5.001	24,005
245	24,50-24,99	25,000	24,200	140,000	56,000	42,300	86843 5.001	24,500
245	24,50-24,99	25,400	24,200	140,000	56,000	42,300	86843 5.001	24,505
250	25,00-25,49	25,000	24,700	142,000	56,000	43,200	86843 5.001	25,000
250	25,00-25,49	25,400	24,700	142,000	56,000	43,200	86843 5.001	25,005
255	25,50-25,99	32,000	25,200	148,000	60,000	44,000	86843 5.001	25,500
255	25,50-25,99	31,750	25,200	148,000	60,000	44,000	86843 5.001	25,505
260	26,00-26,49	32,000	25,700	151,000	60,000	44,300	86843 5.003	26,000
260	26,00-26,49	31,750	25,700	151,000	60,000	44,300	86843 5.003	26,005
265	26,50-26,99	32,000	26,200	153,000	60,000	45,100	86843 5.003	26,500
265	26,50-26,99	31,750	26,200	153,000	60,000	45,100	86843 5.003	26,505
270	27,00-27,49	32,000	26,700	155,000	60,000	46,000	86843 5.003	27,000
270	27,00-27,49	31,750	26,700	155,000	60,000	46,000	86843 5.003	27,005
275	27,50-27,99	32,000	27,200	156,000	60,000	46,800	86843 5.003	27,500
275	27,50-27,99	31,750	27,200	156,000	60,000	46,800	86843 5.003	27,505
280	28,00-28,49	32,000	27,700	157,000	60,000	47,700	86843 5.003	28,000
280	28,00-28,49	31,750	27,700	157,000	60,000	47,700	86843 5.003	28,005
285	28,50-28,99	32,000	28,200	159,000	60,000	48,500	86843 5.003	28,500
285	28,50-28,99	31,750	28,200	159,000	60,000	48,500	86843 5.003	28,505
290	29,00-29,49	32,000	28,700	161,000	60,000	49,400	86843 5.003	29,000
290	29,00-29,49	31,750	28,700	161,000	60,000	49,400	86843 5.003	29,005
295	29,50-29,99	32,000	29,200	162,000	60,000	50,200	86843 5.003	29,500
295	29,50-29,99	31,750	29,200	162,000	60,000	50,200	86843 5.003	29,505
300	30,00-30,49	32,000	29,700	164,000	60,000	50,900	86843 6.000	30,000
300	30,00-30,49	31,750	29,700	164,000	60,000	50,900	86843 6.000	30,005
305	30,50-30,99	32,000	30,200	166,000	60,000	51,700	86843 6.000	30,500
305	30,50-30,99	31,750	30,200	166,000	60,000	51,700	86843 6.000	30,505
310	31,00-31,49	32,000	30,700	167,000	60,000	52,600	86843 6.000	31,000
310	31,00-31,49	31,750	30,700	167,000	60,000	52,600	86843 6.000	31,005
315	31,50-31,99	32,000	31,200	168,000	60,000	53,400	86843 6.000	31,500
315	31,50-31,99	31,750	31,200	168,000	60,000	53,400	86843 6.000	31,505
320	32,00-32,99	32,000	31,700	172,000	60,000	55,100	86843 6.001	32,000
320	32,00-32,99	31,750	31,700	172,000	60,000	55,100	86843 6.001	32,005
330	33,00-33,99	32,000	32,700	175,000	60,000	56,800	86843 6.001	33,000
330	33,00-33,99	31,750	32,700	175,000	60,000	56,800	86843 6.001	33,005
340	34,00-34,99	32,000	33,700	178,000	60,000	58,500	86843 6.001	34,000
340	34,00-34,99	31,750	33,700	178,000	60,000	58,500	86843 6.001	34,005
350	35,00-35,99	32,000	34,700	181,000	60,000	60,200	86843 6.001	35,000
350	35,00-35,99	31,750	34,700	181,000	60,000	60,200	86843 6.001	35,005
360	36,00-36,99	32,000	35,700	184,000	60,000	61,800	86843 6.002	36,000
360	36,00-36,99	31,750	35,700	184,000	60,000	61,800	86843 6.002	36,005
370	37,00-37,99	32,000	36,700	188,000	60,000	63,500	86843 6.002	37,000
370	37,00-37,99	31,750	36,700	188,000	60,000	63,500	86843 6.002	37,005
380	38,00-38,99	32,000	37,700	191,000	60,000	65,200	86843 6.002	38,000
380	38,00-38,99	31,750	37,700	191,000	60,000	65,200	86843 6.002	38,005
390	39,00-40,00	32,000	38,700	194,000	60,000	66,900	86843 6.002	39,000
390	39,00-40,00	31,750	38,700	194,000	60,000	66,900	86843 6.002	39,005



Multiplex HPC-Halter

Artikel-Nr. 86683



besonders hohe Verschleißfestigkeit • optimierter Nutquerschnitt • besonders hohe Stabilität • Spanschrauben Art.-Nr. 86843 enthalten
• Schraubendreher Art.-Nr. 86842 enthalten

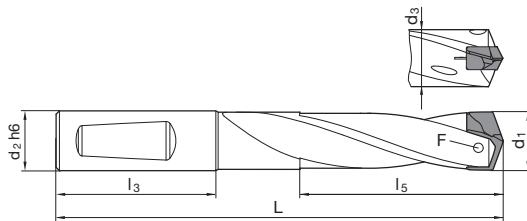

Größe mm	d1	d2 h6 mm	d3 mm	L mm	l3 mm	l5 mm	F	Code-Nr.
110	11,00-11,49	12,000	10,700	101,000	45,000	36,600	86843 2.200	11,000
110	11,00-11,49	12,700	10,700	101,000	45,000	36,600	86843 2.200	11,005
115	11,50-11,99	12,000	11,200	103,000	45,000	38,100	86843 2.200	11,500
115	11,50-11,99	12,700	11,200	103,000	45,000	38,100	86843 2.200	11,505
120	12,00-12,49	12,000	11,700	106,000	45,000	39,700	86843 2.201	12,000
120	12,00-12,49	12,700	11,700	106,000	45,000	39,700	86843 2.201	12,005
125	12,50-12,99	14,000	12,200	108,000	45,000	41,300	86843 2.201	12,500
125	12,50-12,99	15,875	12,200	108,000	45,000	41,300	86843 2.201	12,505
130	13,00-13,49	14,000	12,700	110,000	45,000	42,900	86843 2.500	13,000
130	13,00-13,49	15,875	12,700	110,000	45,000	42,900	86843 2.500	13,005
135	13,50-13,99	14,000	13,200	113,000	45,000	44,600	86843 2.500	13,500
135	13,50-13,99	15,875	13,200	113,000	45,000	44,600	86843 2.500	13,505
140	14,00-14,49	14,000	13,700	115,000	45,000	46,200	86843 3.000	14,000
140	14,00-14,49	15,875	13,700	115,000	45,000	46,200	86843 3.000	14,005
145	14,50-14,99	16,000	14,200	120,000	48,000	47,800	86843 3.000	14,500
145	14,50-14,99	15,875	14,200	120,000	48,000	47,800	86843 3.000	14,505
150	15,00-15,49	16,000	14,700	123,000	48,000	49,300	86843 3.001	15,000
150	15,00-15,49	15,875	14,700	123,000	48,000	49,300	86843 3.001	15,005
155	15,50-15,99	16,000	15,200	125,000	48,000	50,900	86843 3.001	15,500
155	15,50-15,99	15,875	15,200	125,000	48,000	50,900	86843 3.001	15,505
160	16,00-16,49	16,000	15,700	127,000	48,000	52,900	86843 3.500	16,000
160	16,00-16,49	15,875	15,700	127,000	48,000	52,900	86843 3.500	16,005
165	16,50-16,99	18,000	16,200	130,000	48,000	54,100	86843 3.500	16,500
165	16,50-16,99	19,050	16,200	130,000	48,000	54,100	86843 3.500	16,505
170	17,00-17,49	18,000	16,700	132,000	48,000	55,800	86843 3.500	17,000
170	17,00-17,49	19,050	16,700	132,000	48,000	55,800	86843 3.500	17,005
175	17,50-17,99	18,000	17,200	134,000	48,000	57,400	86843 3.500	17,500
175	17,50-17,99	19,050	17,200	134,000	48,000	57,400	86843 3.500	17,505
180	18,00-18,49	18,000	17,700	137,000	48,000	58,900	86843 4.000	18,000
180	18,00-18,49	19,050	17,700	137,000	48,000	58,900	86843 4.000	18,005
185	18,50-18,99	20,000	18,200	141,000	50,000	60,500	86843 4.000	18,500
185	18,50-18,99	19,050	18,200	141,000	50,000	60,500	86843 4.000	18,505
190	19,00-19,49	20,000	18,700	143,000	50,000	62,100	86843 4.000	19,000
190	19,00-19,49	19,050	18,700	143,000	50,000	62,100	86843 4.000	19,005
195	19,50-19,99	20,000	19,200	146,000	50,000	63,700	86843 4.000	19,500
195	19,50-19,99	19,050	19,200	146,000	50,000	63,700	86843 4.000	19,505
200	20,00-20,49	20,000	19,700	148,000	50,000	65,300	86843 4.500	20,000
200	20,00-20,49	19,050	19,700	148,000	50,000	65,300	86843 4.500	20,005
205	20,50-20,99	25,000	20,200	159,000	56,000	67,000	86843 4.500	20,500
205	20,50-20,99	25,400	20,200	159,000	56,000	67,000	86843 4.500	20,505
210	21,00-21,49	25,000	20,700	161,000	56,000	68,600	86843 4.500	21,000
210	21,00-21,49	25,400	20,700	161,000	56,000	68,600	86843 4.500	21,005



Multiplex HPC-Halter

Größe mm	d1	d2 h6 mm	d3 mm	L mm	l3 mm	l5 mm	F	Code-Nr.
215	21,50-21,99	25,000	21,200	163,000	56,000	70,100	86843 4.500	21,500
215	21,50-21,99	25,400	21,200	163,000	56,000	70,100	86843 4.500	21,505
220	22,00-22,49	25,000	21,700	165,000	56,000	71,700	86843 5.000	22,000
220	22,00-22,49	25,400	21,700	165,000	56,000	71,700	86843 5.000	22,005
225	22,50-22,99	25,000	22,200	168,000	56,000	73,300	86843 5.000	22,500
225	22,50-22,99	25,400	22,200	168,000	56,000	73,300	86843 5.000	22,505
230	23,00-23,49	25,000	22,700	170,000	56,000	74,900	86843 5.000	23,000
230	23,00-23,49	25,400	22,700	170,000	56,000	74,900	86843 5.000	23,005
235	23,50-23,99	25,000	23,200	173,000	56,000	76,500	86843 5.000	23,500
235	23,50-23,99	25,400	23,200	173,000	56,000	76,500	86843 5.000	23,505
240	24,00-24,49	25,000	23,700	175,000	56,000	78,100	86843 5.001	24,000
240	24,00-24,49	25,400	23,700	175,000	56,000	78,100	86843 5.001	24,005
245	24,50-24,99	25,000	24,200	177,000	56,000	79,700	86843 5.001	24,500
245	24,50-24,99	25,400	24,200	177,000	56,000	79,700	86843 5.001	24,505
250	25,00-25,49	25,000	24,700	180,000	56,000	81,300	86843 5.001	25,000
250	25,00-25,49	25,400	24,700	180,000	56,000	81,300	86843 5.001	25,005
255	25,50-25,99	32,000	25,200	187,000	60,000	82,900	86843 5.001	25,500
255	25,50-25,99	31,750	25,200	187,000	60,000	82,900	86843 5.001	25,505
260	26,00-26,49	32,000	25,700	191,000	60,000	84,000	86843 5.003	26,000
260	26,00-26,49	31,750	25,700	191,000	60,000	84,000	86843 5.003	26,005
265	26,50-26,99	32,000	26,200	193,000	60,000	86,100	86843 5.003	26,500
265	26,50-26,99	31,750	26,200	193,000	60,000	86,100	86843 5.003	26,505
270	27,00-27,49	32,000	26,700	196,000	60,000	87,200	86843 5.003	27,000
270	27,00-27,49	31,750	26,700	196,000	60,000	87,200	86843 5.003	27,005
275	27,50-27,99	32,000	27,200	198,000	60,000	88,900	86843 5.003	27,500
275	27,50-27,99	31,750	27,200	198,000	60,000	88,900	86843 5.003	27,505
280	28,00-28,49	32,000	27,700	200,000	60,000	90,400	86843 5.003	28,000
280	28,00-28,49	31,750	27,700	200,000	60,000	90,400	86843 5.003	28,005
285	28,50-28,99	32,000	28,200	202,000	60,000	92,500	86843 5.003	28,500
285	28,50-28,99	31,750	28,200	202,000	60,000	92,500	86843 5.003	28,505
290	29,00-29,49	32,000	28,700	205,000	60,000	94,600	86843 5.003	29,000
290	29,00-29,49	31,750	28,700	205,000	60,000	94,600	86843 5.003	29,005
295	29,50-29,99	32,000	29,200	207,000	60,000	95,100	86843 5.003	29,500
295	29,50-29,99	31,750	29,200	207,000	60,000	95,100	86843 5.003	29,505
300	30,00-30,49	32,000	29,700	210,000	60,000	96,700	86843 6.000	30,000
300	30,00-30,49	31,750	29,700	210,000	60,000	96,700	86843 6.000	30,005
305	30,50-30,99	32,000	30,200	212,000	60,000	98,300	86843 6.000	30,500
305	30,50-30,99	31,750	30,200	212,000	60,000	98,300	86843 6.000	30,505
310	31,00-31,49	32,000	30,700	214,000	60,000	99,800	86843 6.000	31,000
310	31,00-31,49	31,750	30,700	214,000	60,000	99,800	86843 6.000	31,005
315	31,50-31,99	32,000	31,200	216,000	60,000	101,400	86843 6.000	31,500
315	31,50-31,99	31,750	31,200	216,000	60,000	101,400	86843 6.000	31,505
320	32,00-32,99	32,000	31,700	221,000	60,000	104,600	86843 6.001	32,000
320	32,00-32,99	31,750	31,700	221,000	60,000	104,600	86843 6.001	32,005
330	33,00-33,99	32,000	32,700	226,000	60,000	107,800	86843 6.001	33,000
330	33,00-33,99	31,750	32,700	226,000	60,000	107,800	86843 6.001	33,005
340	34,00-34,99	32,000	33,700	230,000	60,000	111,000	86843 6.001	34,000
340	34,00-34,99	31,750	33,700	230,000	60,000	111,000	86843 6.001	34,005
350	35,00-35,99	32,000	34,700	235,000	60,000	114,200	86843 6.001	35,000
350	35,00-35,99	31,750	34,700	235,000	60,000	114,200	86843 6.001	35,005
360	36,00-36,99	32,000	35,700	240,000	60,000	117,300	86843 6.002	36,000
360	36,00-36,99	31,750	35,700	240,000	60,000	117,300	86843 6.002	36,005
370	37,00-37,99	32,000	36,700	245,000	60,000	120,500	86843 6.002	37,000
370	37,00-37,99	31,750	36,700	245,000	60,000	120,500	86843 6.002	37,005
380	38,00-38,99	32,000	37,700	249,000	60,000	123,700	86843 6.002	38,000
380	38,00-38,99	31,750	37,700	249,000	60,000	123,700	86843 6.002	38,005
390	39,00-40,00	32,000	38,700	254,000	60,000	126,900	86843 6.002	39,000
390	39,00-40,00	31,750	38,700	254,000	60,000	126,900	86843 6.002	39,005



Multiplex HPC-Halter

Artikel-Nr. 86684



besonders hohe Verschleißfestigkeit • optimierter Nutquerschnitt • besonders hohe Stabilität • Spanschrauben Art.-Nr. 86843 enthalten
• Schraubendreher Art.-Nr. 86842 enthalten

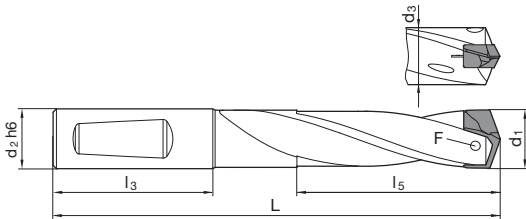

Größe mm	d1	d2 h6 mm	d3 mm	L mm	l3 mm	l5 mm	F	Code-Nr.
110	11,00-11,49	12,000	10,700	124,000	45,000	59,600	86843 2.200	11,000
110	11,00-11,49	12,700	10,700	124,000	45,000	59,600	86843 2.200	11,005
115	11,50-11,99	12,000	11,200	127,000	45,000	62,100	86843 2.200	11,500
115	11,50-11,99	12,700	11,200	127,000	45,000	62,100	86843 2.200	11,505
120	12,00-12,49	12,000	11,700	131,000	45,000	64,700	86843 2.201	12,000
120	12,00-12,49	12,700	11,700	131,000	45,000	64,700	86843 2.201	12,005
125	12,50-12,99	14,000	12,200	134,000	45,000	67,300	86843 2.201	12,500
125	12,50-12,99	15,875	12,200	134,000	45,000	67,300	86843 2.201	12,505
130	13,00-13,49	14,000	12,700	137,000	45,000	69,900	86843 2.500	13,000
130	13,00-13,49	15,875	12,700	137,000	45,000	69,900	86843 2.500	13,005
135	13,50-13,99	14,000	13,200	141,000	45,000	72,600	86843 2.500	13,500
135	13,50-13,99	15,875	13,200	141,000	45,000	72,600	86843 2.500	13,505
140	14,00-14,49	14,000	13,700	144,000	45,000	75,200	86843 3.000	14,000
140	14,00-14,49	15,875	13,700	144,000	45,000	75,200	86843 3.000	14,005
145	14,50-14,99	16,000	14,200	150,000	48,000	77,800	86843 3.000	14,500
145	14,50-14,99	15,875	14,200	150,000	48,000	77,800	86843 3.000	14,505
150	15,00-15,49	16,000	14,700	154,000	48,000	80,300	86843 3.001	15,000
150	15,00-15,49	15,875	14,700	154,000	48,000	80,300	86843 3.001	15,005
155	15,50-15,99	16,000	15,200	157,000	48,000	82,900	86843 3.001	15,500
155	15,50-15,99	15,875	15,200	157,000	48,000	82,900	86843 3.001	15,505
160	16,00-16,49	16,000	15,700	160,000	48,000	85,900	86843 3.500	16,000
160	16,00-16,49	15,875	15,700	160,000	48,000	85,900	86843 3.500	16,005
165	16,50-16,99	18,000	16,200	164,000	48,000	88,100	86843 3.500	16,500
165	16,50-16,99	19,050	16,200	164,000	48,000	88,100	86843 3.500	16,505
170	17,00-17,49	18,000	16,700	167,000	48,000	90,800	86843 3.500	17,000
170	17,00-17,49	19,050	16,700	167,000	48,000	90,800	86843 3.500	17,005
175	17,50-17,99	18,000	17,200	170,000	48,000	93,400	86843 3.500	17,500
175	17,50-17,99	19,050	17,200	170,000	48,000	93,400	86843 3.500	17,505
180	18,00-18,49	18,000	17,700	174,000	48,000	95,900	86843 4.000	18,000
180	18,00-18,49	19,050	17,700	174,000	48,000	95,900	86843 4.000	18,005
185	18,50-18,99	20,000	18,200	179,000	50,000	98,500	86843 4.000	18,500
185	18,50-18,99	19,050	18,200	179,000	50,000	98,500	86843 4.000	18,505
190	19,00-19,49	20,000	18,700	182,000	50,000	101,100	86843 4.000	19,000
190	19,00-19,49	19,050	18,700	182,000	50,000	101,100	86843 4.000	19,005
195	19,50-19,99	20,000	19,200	186,000	50,000	103,700	86843 4.000	19,500
195	19,50-19,99	19,050	19,200	186,000	50,000	103,700	86843 4.000	19,505
200	20,00-20,49	20,000	19,700	189,000	50,000	106,300	86843 4.500	20,000
200	20,00-20,49	19,050	19,700	189,000	50,000	106,300	86843 4.500	20,005
205	20,50-20,99	25,000	20,200	201,000	56,000	109,000	86843 4.500	20,500
205	20,50-20,99	25,400	20,200	201,000	56,000	109,000	86843 4.500	20,505
210	21,00-21,49	25,000	20,700	204,000	56,000	111,600	86843 4.500	21,000
210	21,00-21,49	25,400	20,700	204,000	56,000	111,600	86843 4.500	21,005



Multiplex HPC-Halter

Größe mm	d1	d2 h6 mm	d3 mm	L mm	I3 mm	I5 mm	F	Code-Nr.
215	21,50-21,99	25,000	21,200	207,000	56,000	114,100	86843 4.500	21,500
215	21,50-21,99	25,400	21,200	207,000	56,000	114,100	86843 4.500	21,505
220	22,00-22,49	25,000	21,700	210,000	56,000	116,700	86843 5.000	22,000
220	22,00-22,49	25,400	21,700	210,000	56,000	116,700	86843 5.000	22,005
225	22,50-22,99	25,000	22,200	214,000	56,000	119,300	86843 5.000	22,500
225	22,50-22,99	25,400	22,200	214,000	56,000	119,300	86843 5.000	22,505
230	23,00-23,49	25,000	22,700	217,000	56,000	121,900	86843 5.000	23,000
230	23,00-23,49	25,400	22,700	217,000	56,000	121,900	86843 5.000	23,005
235	23,50-23,99	25,000	23,200	221,000	56,000	124,500	86843 5.000	23,500
235	23,50-23,99	25,400	23,200	221,000	56,000	124,500	86843 5.000	23,505
240	24,00-24,49	25,000	23,700	224,000	56,000	127,100	86843 5.001	24,000
240	24,00-24,49	25,400	23,700	224,000	56,000	127,100	86843 5.001	24,005
245	24,50-24,99	25,000	24,200	227,000	56,000	129,700	86843 5.001	24,500
245	24,50-24,99	25,400	24,200	227,000	56,000	129,700	86843 5.001	24,505
250	25,00-25,49	25,000	24,700	231,000	56,000	132,300	86843 5.001	25,000
250	25,00-25,49	25,400	24,700	231,000	56,000	132,300	86843 5.001	25,005
255	25,50-25,99	32,000	25,200	239,000	60,000	134,900	86843 5.001	25,500
255	25,50-25,99	31,750	25,200	239,000	60,000	134,900	86843 5.001	25,505
260	26,00-26,49	32,000	25,700	244,000	60,000	137,000	86843 5.003	26,000
265	26,50-26,99	32,000	26,200	247,000	60,000	140,000	86843 5.003	26,500
270	27,00-27,49	32,000	26,700	251,000	60,000	142,200	86843 5.003	27,000
275	27,50-27,99	32,000	27,200	254,000	60,000	144,800	86843 5.003	27,500
280	28,00-28,49	32,000	27,700	257,000	60,000	147,400	86843 5.003	28,000
285	28,50-28,99	32,000	28,200	260,000	60,000	150,400	86843 5.003	28,500
290	29,00-29,49	32,000	28,700	264,000	60,000	153,500	86843 5.003	29,000
295	29,50-29,99	32,000	29,200	267,000	60,000	155,100	86843 5.003	29,500
300	30,00-30,49	32,000	29,700	271,000	60,000	157,600	86843 6.000	30,000
305	30,50-30,99	32,000	30,200	274,000	60,000	160,200	86843 6.000	30,500
310	31,00-31,49	32,000	30,700	277,000	60,000	162,800	86843 6.000	31,000
315	31,50-31,99	32,000	31,200	280,000	60,000	165,400	86843 6.000	31,500
320	32,00-32,99	32,000	31,700	287,000	60,000	170,600	86843 6.001	32,000
330	33,00-33,99	32,000	32,700	294,000	60,000	175,800	86843 6.001	33,000
340	34,00-34,99	32,000	33,700	300,000	60,000	181,000	86843 6.001	34,000
350	35,00-35,99	32,000	34,700	307,000	60,000	186,200	86843 6.001	35,000
360	36,00-36,99	32,000	35,700	314,000	60,000	191,300	86843 6.002	36,000
370	37,00-37,99	32,000	36,700	321,000	60,000	196,500	86843 6.002	37,000
380	38,00-38,99	32,000	37,700	327,000	60,000	201,700	86843 6.002	38,000
390	39,00-40,00	32,000	38,700	334,000	60,000	206,900	86843 6.002	39,000



Multiplex HPC-Halter

Artikel-Nr. 86685



besonders hohe Verschleißfestigkeit • optimierter Nutquerschnitt • besonders hohe Stabilität • Spanschrauben Art.-Nr. 86843 enthalten
• Schraubendreher Art.-Nr. 86842 enthalten

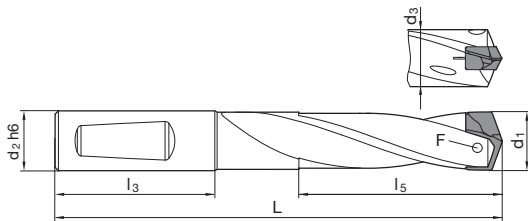

Größe mm	d1	d2 h6 mm	d3 mm	L mm	l3 mm	l5 mm	F	Code-Nr.
110	11,00-11,49	12,000	10,700	147,000	45,000	82,600	86843 2.200	11,000
110	11,00-11,49	12,700	10,700	147,000	45,000	82,600	86843 2.200	11,005
115	11,50-11,99	12,000	11,200	151,000	45,000	86,100	86843 2.200	11,500
115	11,50-11,99	12,700	11,200	151,000	45,000	86,100	86843 2.200	11,505
120	12,00-12,49	12,000	11,700	156,000	45,000	89,700	86843 2.201	12,000
120	12,00-12,49	12,700	11,700	156,000	45,000	89,700	86843 2.201	12,005
125	12,50-12,99	14,000	12,200	160,000	45,000	93,300	86843 2.201	12,500
125	12,50-12,99	15,875	12,200	160,000	45,000	93,300	86843 2.201	12,505
130	13,00-13,49	14,000	12,700	164,000	45,000	96,900	86843 2.500	13,000
130	13,00-13,49	15,875	12,700	164,000	45,000	96,900	86843 2.500	13,005
135	13,50-13,99	14,000	13,200	169,000	45,000	100,600	86843 2.500	13,500
135	13,50-13,99	15,875	13,200	169,000	45,000	100,600	86843 2.500	13,505
140	14,00-14,49	14,000	13,700	173,000	45,000	104,200	86843 3.000	14,000
140	14,00-14,49	15,875	13,700	173,000	45,000	104,200	86843 3.000	14,005
145	14,50-14,99	16,000	14,200	180,000	48,000	107,800	86843 3.000	14,500
145	14,50-14,99	15,875	14,200	180,000	48,000	107,800	86843 3.000	14,505
150	15,00-15,49	16,000	14,700	185,000	48,000	111,300	86843 3.001	15,000
150	15,00-15,49	15,875	14,700	185,000	48,000	111,300	86843 3.001	15,005
155	15,50-15,99	16,000	15,200	189,000	48,000	114,900	86843 3.001	15,500
155	15,50-15,99	15,875	15,200	189,000	48,000	114,900	86843 3.001	15,505
160	16,00-16,49	16,000	15,700	193,000	48,000	118,900	86843 3.500	16,000
160	16,00-16,49	15,875	15,700	193,000	48,000	118,900	86843 3.500	16,005
165	16,50-16,99	18,000	16,200	198,000	48,000	122,100	86843 3.500	16,500
165	16,50-16,99	19,050	16,200	198,000	48,000	122,100	86843 3.500	16,505
170	17,00-17,49	18,000	16,700	202,000	48,000	125,800	86843 3.500	17,000
170	17,00-17,49	19,050	16,700	202,000	48,000	125,800	86843 3.500	17,005
175	17,50-17,99	18,000	17,200	206,000	48,000	129,400	86843 3.500	17,500
175	17,50-17,99	19,050	17,200	206,000	48,000	129,400	86843 3.500	17,505
180	18,00-18,49	18,000	17,700	211,000	48,000	132,900	86843 4.000	18,000
180	18,00-18,49	19,050	17,700	211,000	48,000	132,900	86843 4.000	18,005
185	18,50-18,99	20,000	18,200	217,000	50,000	136,500	86843 4.000	18,500
185	18,50-18,99	19,050	18,200	217,000	50,000	136,500	86843 4.000	18,505
190	19,00-19,49	20,000	18,700	221,000	50,000	140,100	86843 4.000	19,000
190	19,00-19,49	19,050	18,700	221,000	50,000	140,100	86843 4.000	19,005
195	19,50-19,99	20,000	19,200	226,000	50,000	143,700	86843 4.000	19,500
195	19,50-19,99	19,050	19,200	226,000	50,000	143,700	86843 4.000	19,505
200	20,00-20,49	20,000	19,700	230,000	50,000	147,300	86843 4.500	20,000
200	20,00-20,49	19,050	19,700	230,000	50,000	147,300	86843 4.500	20,005
205	20,50-20,99	25,000	20,200	243,000	56,000	151,000	86843 4.500	20,500
205	20,50-20,99	25,400	20,200	243,000	56,000	151,000	86843 4.500	20,505
210	21,00-21,49	25,000	20,700	247,000	56,000	154,600	86843 4.500	21,000
210	21,00-21,49	25,400	20,700	247,000	56,000	154,600	86843 4.500	21,005



Multiplex HPC-Halter

Größe mm	d1	d2 h6 mm	d3 mm	L mm	I3 mm	I5 mm	F	Code-Nr.
215	21,50-21,99	25,000	21,200	251,000	56,000	158,100	86843 4.500	21,500
215	21,50-21,99	25,400	21,200	251,000	56,000	158,100	86843 4.500	21,505
220	22,00-22,49	25,000	21,700	255,000	56,000	161,700	86843 5.000	22,000
220	22,00-22,49	25,400	21,700	255,000	56,000	161,700	86843 5.000	22,005
225	22,50-22,99	25,000	22,200	260,000	56,000	165,300	86843 5.000	22,500
225	22,50-22,99	25,400	22,200	260,000	56,000	165,300	86843 5.000	22,505
230	23,00-23,49	25,000	22,700	264,000	56,000	168,900	86843 5.000	23,000
230	23,00-23,49	25,400	22,700	264,000	56,000	168,900	86843 5.000	23,005
235	23,50-23,99	25,000	23,200	269,000	56,000	172,500	86843 5.000	23,500
235	23,50-23,99	25,400	23,200	269,000	56,000	172,500	86843 5.000	23,505
240	24,00-24,49	25,000	23,700	273,000	56,000	176,100	86843 5.001	24,000
240	24,00-24,49	25,400	23,700	273,000	56,000	176,100	86843 5.001	24,005
245	24,50-24,99	25,000	24,200	277,000	56,000	179,700	86843 5.001	24,500
245	24,50-24,99	25,400	24,200	277,000	56,000	179,700	86843 5.001	24,505
250	25,00-25,49	25,000	24,700	282,000	56,000	183,300	86843 5.001	25,000
250	25,00-25,49	25,400	24,700	282,000	56,000	183,300	86843 5.001	25,005
255	25,50-25,99	32,000	25,200	291,000	60,000	186,900	86843 5.001	25,500
255	25,50-25,99	31,750	25,200	291,000	60,000	186,900	86843 5.001	25,505
260	26,00-26,49	32,000	25,700	297,000	60,000	190,000	86843 5.003	26,000
260	26,00-26,49	31,750	25,700	297,000	60,000	190,000	86843 5.003	26,005
265	26,50-26,99	32,000	26,200	301,000	60,000	194,000	86843 5.003	26,500
265	26,50-26,99	31,750	26,200	301,000	60,000	194,000	86843 5.003	26,505
270	27,00-27,49	32,000	26,700	306,000	60,000	197,200	86843 5.003	27,000
270	27,00-27,49	31,750	26,700	306,000	60,000	197,200	86843 5.003	27,005
275	27,50-27,99	32,000	27,200	310,000	60,000	200,800	86843 5.003	27,500
275	27,50-27,99	31,750	27,200	310,000	60,000	200,800	86843 5.003	27,505
280	28,00-28,49	32,000	27,700	314,000	60,000	204,400	86843 5.003	28,000
280	28,00-28,49	31,750	27,700	314,000	60,000	204,400	86843 5.003	28,005
285	28,50-28,99	32,000	28,200	318,000	60,000	208,400	86843 5.003	28,500
285	28,50-28,99	31,750	28,200	318,000	60,000	208,400	86843 5.003	28,505
290	29,00-29,49	32,000	28,700	323,000	60,000	212,500	86843 5.003	29,000
290	29,00-29,49	31,750	28,700	323,000	60,000	212,500	86843 5.003	29,005
295	29,50-29,99	32,000	29,200	327,000	60,000	215,100	86843 5.003	29,500
295	29,50-29,99	31,750	29,200	327,000	60,000	215,100	86843 5.003	29,505
300	30,00-30,49	32,000	29,700	332,000	60,000	218,600	86843 6.000	30,000
300	30,00-30,49	31,750	29,700	332,000	60,000	218,600	86843 6.000	30,005
305	30,50-30,99	32,000	30,200	336,000	60,000	222,200	86843 6.000	30,500
305	30,50-30,99	31,750	30,200	336,000	60,000	222,200	86843 6.000	30,505
310	31,00-31,49	32,000	30,700	340,000	60,000	225,800	86843 6.000	31,000
310	31,00-31,49	31,750	30,700	340,000	60,000	225,800	86843 6.000	31,005
315	31,50-31,99	32,000	31,200	344,000	60,000	229,400	86843 6.000	31,500
315	31,50-31,99	31,750	31,200	344,000	60,000	229,400	86843 6.000	31,505



Multiplex HPC-Halter

Artikel-Nr. 86686



besonders hohe Verschleißfestigkeit • optimierter Nutquerschnitt • besonders hohe Stabilität • Spanschrauben Art.-Nr. 86843 enthalten
• Schraubendreher Art.-Nr. 86842 enthalten

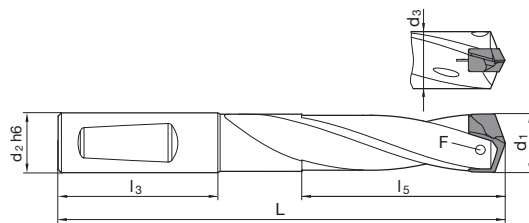

Größe mm	d1	d2 h6 mm	d3 mm	L mm	l3 mm	l5 mm	F	Code-Nr.
110	11,00-11,49	12,000	10,700	182,000	45,000	117,100	86843 2.200	11,000
110	11,00-11,49	12,700	10,700	182,000	45,000	117,100	86843 2.200	11,005
115	11,50-11,99	12,000	11,200	187,000	45,000	122,100	86843 2.200	11,500
115	11,50-11,99	12,700	11,200	187,000	45,000	122,100	86843 2.200	11,505
120	12,00-12,49	12,000	11,700	194,000	45,000	127,200	86843 2.201	12,000
120	12,00-12,49	12,700	11,700	194,000	45,000	127,200	86843 2.201	12,005
125	12,50-12,99	14,000	12,200	199,000	45,000	132,300	86843 2.201	12,500
125	12,50-12,99	15,875	12,200	199,000	45,000	132,300	86843 2.201	12,505
130	13,00-13,49	14,000	12,700	205,000	45,000	137,500	86843 2.500	13,000
130	13,00-13,49	15,875	12,700	205,000	45,000	137,500	86843 2.500	13,005
135	13,50-13,99	14,000	13,200	211,000	45,000	142,500	86843 2.500	13,500
135	13,50-13,99	15,875	13,200	211,000	45,000	142,500	86843 2.500	13,505
140	14,00-14,49	14,000	13,700	217,000	45,000	147,700	86843 3.000	14,000
140	14,00-14,49	15,875	13,700	217,000	45,000	147,700	86843 3.000	14,005
145	14,50-14,99	16,000	14,200	225,000	48,000	152,800	86843 3.000	14,500
145	14,50-14,99	15,875	14,200	225,000	48,000	152,800	86843 3.000	14,505
150	15,00-15,49	16,000	14,700	232,000	48,000	157,800	86843 3.001	15,000
150	15,00-15,49	15,875	14,700	232,000	48,000	157,800	86843 3.001	15,005
155	15,50-15,99	16,000	15,200	237,000	48,000	162,900	86843 3.001	15,500
155	15,50-15,99	15,875	15,200	237,000	48,000	162,900	86843 3.001	15,505
160	16,00-16,49	16,000	15,700	243,000	48,000	168,000	86843 3.500	16,000
160	16,00-16,49	15,875	15,700	243,000	48,000	168,000	86843 3.500	16,005
165	16,50-16,99	18,000	16,200	249,000	48,000	170,000	86843 3.500	16,500
165	16,50-16,99	19,050	16,200	249,000	48,000	170,000	86843 3.500	16,505
170	17,00-17,49	18,000	16,700	255,000	48,000	178,300	86843 3.500	17,000
170	17,00-17,49	19,050	16,700	255,000	48,000	178,300	86843 3.500	17,005
175	17,50-17,99	18,000	17,200	260,000	48,000	183,500	86843 3.500	17,500
175	17,50-17,99	19,050	17,200	260,000	48,000	183,500	86843 3.500	17,505
180	18,00-18,49	18,000	17,700	267,000	48,000	188,400	86843 4.000	18,000
180	18,00-18,49	19,050	17,700	267,000	48,000	188,400	86843 4.000	18,005
185	18,50-18,99	20,000	18,200	274,000	50,000	193,500	86843 4.000	18,500
185	18,50-18,99	19,050	18,200	274,000	50,000	193,500	86843 4.000	18,505
190	19,00-19,49	20,000	18,700	280,000	50,000	198,700	86843 4.000	19,000
190	19,00-19,49	19,050	18,700	280,000	50,000	198,700	86843 4.000	19,005
195	19,50-19,99	20,000	19,200	286,000	50,000	203,700	86843 4.000	19,500
195	19,50-19,99	19,050	19,200	286,000	50,000	203,700	86843 4.000	19,505
200	20,00-20,49	20,000	19,700	292,000	50,000	208,900	86843 4.500	20,000
200	20,00-20,49	19,050	19,700	292,000	50,000	208,900	86843 4.500	20,005
205	20,50-20,99	25,000	20,200	306,000	56,000	214,000	86843 4.500	20,500
205	20,50-20,99	25,400	20,200	306,000	56,000	214,000	86843 4.500	20,505
210	21,00-21,49	25,000	20,700	312,000	56,000	219,100	86843 4.500	21,000
210	21,00-21,49	25,400	20,700	312,000	56,000	219,100	86843 4.500	21,005



Multiplex HPC-Halter

Größe mm	d1	d2 h6 mm	d3 mm	L mm	l3 mm	l5 mm	F	Code-Nr.
215	21,50-21,99	25,000	21,200	317,000	56,000	224,200	86843 4.500	21,500
215	21,50-21,99	25,400	21,200	317,000	56,000	224,200	86843 4.500	21,505
220	22,00-22,49	25,000	21,700	323,000	56,000	229,300	86843 5.000	22,000
220	22,00-22,49	25,400	21,700	323,000	56,000	229,300	86843 5.000	22,005
225	22,50-22,99	25,000	22,200	329,000	56,000	234,400	86843 5.000	22,500
225	22,50-22,99	25,400	22,200	329,000	56,000	234,400	86843 5.000	22,505
230	23,00-23,49	25,000	22,700	335,000	56,000	239,500	86843 5.000	23,000
230	23,00-23,49	25,400	22,700	335,000	56,000	239,500	86843 5.000	23,005
235	23,50-23,99	25,000	23,200	341,000	56,000	244,600	86843 5.000	23,500
235	23,50-23,99	25,400	23,200	341,000	56,000	244,600	86843 5.000	23,505
240	24,00-24,49	25,000	23,700	347,000	56,000	249,700	86843 5.001	24,000
240	24,00-24,49	25,400	23,700	347,000	56,000	249,700	86843 5.001	24,005
245	24,50-24,99	25,000	24,200	352,000	56,000	254,800	86843 5.001	24,500
245	24,50-24,99	25,400	24,200	352,000	56,000	254,800	86843 5.001	24,505
250	25,00-25,49	25,000	24,700	359,000	56,000	259,900	86843 5.001	25,000
250	25,00-25,49	25,400	24,700	359,000	56,000	259,900	86843 5.001	25,005
255	25,50-25,99	32,000	25,200	369,000	60,000	265,000	86843 5.001	25,500
255	25,50-25,99	31,750	25,200	369,000	60,000	265,000	86843 5.001	25,505
260	26,00-26,49	32,000	25,700	377,000	60,000	270,000	86843 5.003	26,000
260	26,00-26,49	31,750	25,700	377,000	60,000	270,000	86843 5.003	26,005
265	26,50-26,99	32,000	26,200	382,000	60,000	275,000	86843 5.003	26,500
265	26,50-26,99	31,750	26,200	382,000	60,000	275,000	86843 5.003	26,505
270	27,00-27,49	32,000	26,700	388,000	60,000	280,100	86843 5.003	27,000
270	27,00-27,49	31,750	26,700	388,000	60,000	280,100	86843 5.003	27,005
275	27,50-27,99	32,000	27,200	394,000	60,000	285,200	86843 5.003	27,500
275	27,50-27,99	31,750	27,200	394,000	60,000	285,200	86843 5.003	27,505
280	28,00-28,49	32,000	27,700	400,000	60,000	290,300	86843 5.003	28,000
280	28,00-28,49	31,750	27,700	400,000	60,000	290,300	86843 5.003	28,005
285	28,50-28,99	32,000	28,200	405,000	60,000	295,400	86843 5.003	28,500
285	28,50-28,99	31,750	28,200	405,000	60,000	295,400	86843 5.003	28,505
290	29,00-29,49	32,000	28,700	412,000	60,000	300,500	86843 5.003	29,000
290	29,00-29,49	31,750	28,700	412,000	60,000	300,500	86843 5.003	29,005
295	29,50-29,99	32,000	29,200	418,000	60,000	305,600	86843 5.003	29,500
295	29,50-29,99	31,750	29,200	418,000	60,000	305,600	86843 5.003	29,505
300	30,00-30,49	32,000	29,700	424,000	60,000	310,600	86843 6.000	30,000
300	30,00-30,49	31,750	29,700	424,000	60,000	310,600	86843 6.000	30,005
305	30,50-30,99	32,000	30,200	429,000	60,000	315,700	86843 6.000	30,500
305	30,50-30,99	31,750	30,200	429,000	60,000	315,700	86843 6.000	30,505
310	31,00-31,49	32,000	30,700	435,000	60,000	320,800	86843 6.000	31,000
310	31,00-31,49	31,750	30,700	435,000	60,000	320,800	86843 6.000	31,005
315	31,50-31,99	32,000	31,200	441,000	60,000	325,900	86843 6.000	31,500
315	31,50-31,99	31,750	31,200	441,000	60,000	325,900	86843 6.000	31,505



Multiplex HPC-Halter

Artikel-Nr. 86681



besonders hohe Verschleißfestigkeit • optimierter Nutquerschnitt • optimierter Kühlkanalaustritt • Spannschrauben Art.-Nr. 86843 und 86846 enthalten • Schraubendreher Art.-Nr. 86842 enthalten zum Pilotieren und Senken 45°

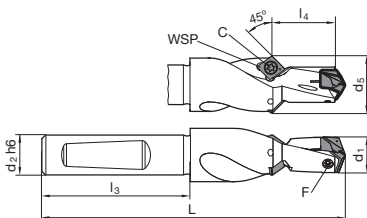

Größe mm	d1	d2 h6 mm	d5 mm	L mm	l3 mm	l4 mm	F	C	Code-Nr.
110	11,00-11,99	12,000	17,000	81,000	45,000	12,000	86843 2.200	86846 2.000	11,000
110	11,00-11,99	12,700	17,000	81,000	45,000	12,000	86843 2.200	86846 2.000	11,005
120	12,00-12,99	12,000	18,000	84,000	45,000	13,000	86843 2.201	86846 2.000	12,000
120	12,00-12,99	12,700	18,000	84,000	45,000	13,000	86843 2.201	86846 2.000	12,005
130	13,00-13,99	14,000	18,000	86,000	45,000	14,000	86843 2.500	86846 2.000	13,000
130	13,00-13,99	15,875	18,000	86,000	45,000	14,000	86843 2.500	86846 2.000	13,005
140	14,00-15,99	16,000	18,000	93,000	48,000	16,000	86843 3.000	86846 2.000	14,000
140	14,00-15,99	15,875	18,000	93,000	48,000	16,000	86843 3.000	86846 2.000	14,005
160	16,00-17,99	18,000	20,000	99,000	48,000	18,000	86843 3.500	86846 2.500	16,000
160	16,00-17,99	19,050	20,000	99,000	48,000	18,000	86843 3.500	86846 2.500	16,005
180	18,00-19,99	20,000	22,000	106,000	50,000	20,000	86843 4.000	86846 2.500	18,000
180	18,00-19,99	19,050	22,000	106,000	50,000	20,000	86843 4.000	86846 2.500	18,005
200	20,00-21,99	25,000	25,000	117,000	56,000	22,000	86843 4.500	86846 2.500	20,000
200	20,00-21,99	25,400	25,400	117,000	56,000	22,000	86843 4.500	86846 2.500	20,005
220	22,00-23,99	25,000	26,000	122,000	56,000	24,000	86843 5.000	86846 2.500	22,000
220	22,00-23,99	25,400	26,000	122,000	56,000	24,000	86843 5.000	86846 2.500	22,005
240	24,00-25,99	25,000	28,000	128,000	56,000	26,000	86843 5.001	86846 2.500	24,000
240	24,00-25,99	25,400	28,000	128,000	56,000	26,000	86843 5.001	86846 2.500	24,005
260	26,00-27,99	32,000	32,000	142,000	60,000	28,000	86843 5.003	86846 2.500	26,000
260	26,00-27,99	31,750	32,000	142,000	60,000	28,000	86843 5.003	86846 2.500	26,005
280	28,00-29,99	32,000	34,000	147,000	60,000	30,000	86843 5.003	86846 2.500	28,000
280	28,00-29,99	31,750	34,000	147,000	60,000	30,000	86843 5.003	86846 2.500	28,005
300	30,00-31,99	32,000	38,000	152,000	60,000	32,000	86843 6.000	86846 4.006	30,000
300	30,00-31,99	31,750	38,000	152,000	60,000	32,000	86843 6.000	86846 4.006	30,005
320	32,00-35,99	32,000	42,000	163,000	60,000	36,000	86843 6.001	86846 4.006	32,000
320	32,00-35,99	31,750	42,000	163,000	60,000	36,000	86843 6.001	86846 4.006	32,005
360	36,00-40,00	32,000	46,000	173,000	60,000	40,000	86843 6.002	86846 4.006	36,000
360	36,00-40,00	31,750	46,000	173,000	60,000	40,000	86843 6.002	86846 4.006	36,005



Multiplex HPC-Wechselplatten

Artikel-Nr. 86722



P	M	K	N	S	H
●	○	○			



Ausspitzung $\geq \varnothing 11,000$ • Flächenanschliff • Hauptschneidenform gerade (durch Korrektur) • Spanschrauben Art.-Nr. 86843 enthalten
 Bau- und Einsatzstähle • Automatenstähle, Vergütungsstähle • legierte Stähle bis 1200 N/mm²

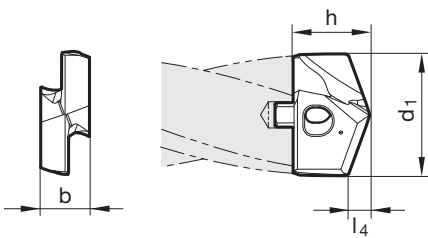

Größe	d1 mm	inch	l4 mm	b mm	h mm	Code-Nr.
110	11,000		2,100	4,500	7,500	11,000
110	11,200		2,100	4,500	7,500	11,200
115	11,500		2,100	4,500	7,500	11,500
115	11,510	29/64	2,100	4,500	7,500	11,510
115	11,700		2,200	4,500	7,500	11,700
115	11,800		2,200	4,500	7,500	11,800
115	11,910	15/32	2,200	4,500	7,500	11,910
120	12,000		2,200	5,000	7,700	12,000
120	12,100		2,300	5,000	7,700	12,100
120	12,200		2,300	5,000	7,700	12,200
120	12,300	31/64	2,300	5,000	7,700	12,300
125	12,500		2,300	5,000	7,700	12,500
125	12,600		2,300	5,000	7,700	12,600
125	12,700	1/2	2,400	5,000	7,700	12,700
125	12,800		2,400	5,000	7,700	12,800
125	12,900		2,400	5,000	7,700	12,900
130	13,000		2,400	5,500	8,500	13,000
130	13,100	33/64	2,400	5,500	8,500	13,100
130	13,490	17/32	2,500	5,500	8,500	13,490
135	13,500		2,500	5,500	8,500	13,500
135	13,600		2,500	5,500	8,500	13,600
135	13,700		2,500	5,500	8,500	13,700
135	13,800		2,600	5,500	8,500	13,800
135	13,890	35/64	2,600	5,500	8,500	13,890
140	14,000		2,600	6,000	9,600	14,000
140	14,100		2,600	6,000	9,600	14,100
140	14,290	9/16	2,700	6,000	9,600	14,290
140	14,400		2,700	6,000	9,600	14,400
145	14,500		2,700	6,000	9,600	14,500
145	14,600		2,700	6,000	9,600	14,600
145	14,680	37/64	2,700	6,000	9,600	14,680
145	14,700		2,700	6,000	9,600	14,700
145	14,800		2,700	6,000	9,600	14,800
150	15,000		2,800	6,000	9,800	15,000
150	15,080	19/32	2,800	6,000	9,800	15,080
150	15,100		2,800	6,000	9,800	15,100
150	15,200		2,800	6,000	9,800	15,200
150	15,300		2,800	6,000	9,800	15,300
150	15,480	39/64	2,900	6,000	9,800	15,480
155	15,500		2,900	6,000	9,800	15,500
155	15,600		2,900	6,000	9,800	15,600
155	15,700		2,900	6,000	9,800	15,700



Multiplex HPC-Wechselplatten

Größe	d1 mm	inch	l4 mm	b mm	h mm	Code-Nr.
155	15,800		2,900	6,000	9,800	15,800
155	15,870	5/8	2,900	6,000	9,800	15,870
160	16,000		3,000	7,000	11,000	16,000
160	16,270	41/64	3,000	7,000	11,000	16,270
165	16,500		3,100	7,000	11,000	16,500
165	16,670	21/32	3,100	7,000	11,000	16,670
170	17,000		3,100	7,000	11,000	17,000
170	17,070	43/64	3,200	7,000	11,000	17,070
170	17,460	11/16	3,200	7,000	11,000	17,460
175	17,500		3,200	7,000	11,000	17,500
175	17,600		3,300	7,000	11,000	17,600
175	17,860	45/64	3,300	7,000	11,000	17,860
180	18,000		3,300	8,000	12,600	18,000
180	18,260	23/32	3,400	8,000	12,600	18,260
185	18,500		3,400	8,000	12,600	18,500
185	18,650	47/64	3,400	8,000	12,600	18,650
190	19,000		3,500	8,000	12,600	19,000
190	19,050	3/4	3,500	8,000	12,600	19,050
190	19,250		3,600	8,000	12,600	19,250
190	19,450	49/64	3,600	8,000	12,600	19,450
195	19,500		3,600	8,000	12,600	19,500
195	19,600		3,600	8,000	12,600	19,600
195	19,840	25/32	3,700	8,000	12,600	19,840
200	20,000		3,700	9,000	13,900	20,000
200	20,240	51/64	3,700	9,000	13,900	20,240
205	20,500		3,800	9,000	13,900	20,500
205	20,640	13/16	3,800	9,000	13,900	20,640
210	21,000		3,900	9,000	13,900	21,000
210	21,030	53/64	3,900	9,000	13,900	21,030
210	21,100		3,900	9,000	13,900	21,100
210	21,430	27/32	3,900	9,000	13,900	21,430
215	21,500		4,000	9,000	13,900	21,500
215	21,830	55/64	4,000	9,000	13,900	21,830
220	22,000		4,100	10,000	15,300	22,000
220	22,220	7/8	4,100	10,000	15,300	22,220
225	22,500		4,100	10,000	15,300	22,500
225	22,620	57/64	4,200	10,000	15,300	22,620
230	23,000		4,200	10,000	15,300	23,000
230	23,020	29/32	4,200	10,000	15,300	23,020
230	23,420	59/64	4,300	10,000	15,300	23,420
235	23,500		4,300	10,000	15,300	23,500
235	23,810	15/16	4,400	10,000	15,300	23,810
240	24,000		4,400	11,000	15,800	24,000
240	24,100		4,400	11,000	15,800	24,100
240	24,210	61/64	4,500	11,000	15,800	24,210
245	24,500		4,500	11,000	15,800	24,500
245	24,610	31/32	4,500	11,000	15,800	24,610
250	25,000	63/64	4,600	11,000	15,800	25,000
250	25,400	1	4,700	11,000	15,800	25,400
255	25,500		4,700	11,000	15,800	25,500
255	25,670		4,700	11,000	15,800	25,670
255	25,700		4,700	11,000	15,800	25,700
255	25,810		4,700	11,000	15,800	25,810
260	26,000		4,800	12,000	20,000	26,000
260	26,190	1 1/32	4,800	12,000	20,000	26,190
265	26,500		4,900	12,000	20,000	26,500
265	26,590	1 3/64	4,900	12,000	20,000	26,590
270	27,000		5,000	12,000	20,000	27,000
275	27,500		5,100	12,000	20,000	27,500
275	27,700		5,100	12,000	20,000	27,700
275	27,780	1 3/32	5,100	12,000	20,000	27,780
280	28,000		5,100	13,000	20,700	28,000
280	28,180	1 7/64	5,200	13,000	20,700	28,180
285	28,500		5,200	13,000	20,700	28,500
285	28,580		5,300	13,000	20,700	28,580
290	29,000		5,300	13,000	20,700	29,000
290	29,370	1 5/32	5,400	13,000	20,700	29,370
295	29,500		5,400	13,000	20,700	29,500
295	29,770	1 11/64	5,500	13,000	20,700	29,770
300	30,000		5,500	14,000	22,300	30,000
300	30,160	1 3/16	5,500	14,000	22,300	30,160
305	30,500		5,600	14,000	22,300	30,500



Multiplex HPC-Wechselplatten

Größe	d1 mm	inch	l4 mm	b mm	h mm	Code-Nr.
305	30,960	1 7/32	5,700	14,000	22,300	30,960
310	31,000		5,700	14,000	22,300	31,000
315	31,500		5,800	14,000	22,300	31,500
315	31,750	1 1/4	5,800	14,000	22,300	31,750
320	32,000		5,900	15,000	23,100	32,000
320	32,500		6,000	15,000	23,100	32,500
320	32,540	1 9/32	6,000	15,000	23,100	32,540
320	32,940	1 19/64	6,000	15,000	23,100	32,940
330	33,000		6,100	15,000	23,100	33,000
330	33,340	1 5/16	6,100	15,000	23,100	33,340
330	33,500		6,100	15,000	23,100	33,500
340	34,000		6,200	15,000	23,100	34,000
340	34,130	1 11/32	6,300	15,000	23,100	34,130
340	34,500		6,300	15,000	23,100	34,500
340	34,930		6,400	15,000	23,100	34,930
350	35,000		6,400	15,000	23,100	35,000
350	35,500		6,500	15,000	23,100	35,500
350	35,720	1 13/32	6,600	15,000	23,100	35,720
360	36,000		6,600	16,000	23,900	36,000
360	36,500		6,700	16,000	23,900	36,500
360	36,510	1 7/16	6,700	16,000	23,900	36,510
370	37,000		6,800	16,000	23,900	37,000
370	37,310	1 15/32	6,800	16,000	23,900	37,310
370	37,500		6,900	16,000	23,900	37,500
380	38,000		7,000	16,000	23,900	38,000
380	38,100	1 1/2	7,000	16,000	23,900	38,100
380	38,500	1 33/64	7,100	16,000	23,900	38,500
390	39,000		7,100	16,000	23,900	39,000
390	39,500		7,200	16,000	23,900	39,500
400	40,000		7,300	16,000	23,900	40,000



ANWENDUNGSBEISPIEL STAHLFLANSCH

Werkzeug-Typ	Multiplex HPC
Artikel-Nr. WP	86722
Artikel-Nr. Halter	86683
Durchmesser	26 mm
Bohrtiefe	80 mm
Material	36NiCrMo6
Kühlung	IK 20 bar
Schmierstoff	Emulsion
Maschine	BAZ
v_c	100 m/min
f	0,4 mm/U
Standweg	40 m



Multiplex HPC-Wechselplatten

Artikel-Nr. 86725



P	M	K	N	S	H
○	●			○	○



Ausspitzung $\geq \varnothing 11,000$ • Kegelmantelanschliff • Hauptschneidenform gerade (durch Korrektur) • Spannschrauben Art.-Nr. 86843 enthalten

rostfreie Stähle

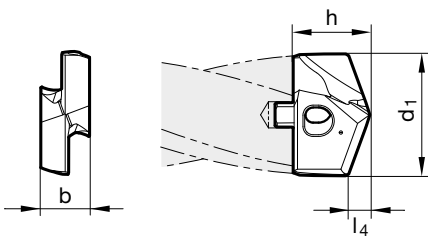

Größe	d1 mm	inch	l4 mm	b mm	h mm	Code-Nr.
110	11,000		2,100	4,500	7,500	11,000
110	11,200		2,100	4,500	7,500	11,200
115	11,500		2,100	4,500	7,500	11,500
115	11,510	29/64	2,100	4,500	7,500	11,510
115	11,700		2,200	4,500	7,500	11,700
115	11,800		2,200	4,500	7,500	11,800
115	11,910	15/32	2,200	4,500	7,500	11,910
120	12,000		2,200	5,000	7,700	12,000
120	12,100		2,300	5,000	7,700	12,100
120	12,200		2,300	5,000	7,700	12,200
120	12,300	31/64	2,300	5,000	7,700	12,300
125	12,500		2,300	5,000	7,700	12,500
125	12,600		2,300	5,000	7,700	12,600
125	12,700	1/2	2,400	5,000	7,700	12,700
125	12,800		2,400	5,000	7,700	12,800
125	12,900		2,400	5,000	7,700	12,900
130	13,000		2,400	5,500	8,500	13,000
130	13,100	33/64	2,400	5,500	8,500	13,100
130	13,490	17/32	2,500	5,500	8,500	13,490
135	13,500		2,500	5,500	8,500	13,500
135	13,600		2,500	5,500	8,500	13,600
135	13,700		2,500	5,500	8,500	13,700
135	13,800		2,600	5,500	8,500	13,800
135	13,890	35/64	2,600	5,500	8,500	13,890
140	14,000		2,600	6,000	9,600	14,000
140	14,100		2,600	6,000	9,600	14,100
140	14,290	9/16	2,700	6,000	9,600	14,290
140	14,400		2,700	6,000	9,600	14,400
145	14,500		2,700	6,000	9,600	14,500
145	14,600		2,700	6,000	9,600	14,600
145	14,700		2,700	6,000	9,600	14,700
145	14,800		2,700	6,000	9,600	14,800
150	15,000		2,800	6,000	9,800	15,000
150	15,080	19/32	2,800	6,000	9,800	15,080
150	15,100		2,800	6,000	9,800	15,100
150	15,200		2,800	6,000	9,800	15,200
150	15,300		2,800	6,000	9,800	15,300
155	15,500		2,900	6,000	9,800	15,500
155	15,600		2,900	6,000	9,800	15,600
155	15,700		2,900	6,000	9,800	15,700
155	15,800		2,900	6,000	9,800	15,800
155	15,870	5/8	2,900	6,000	9,800	15,870



Multiplex HPC-Wechselplatten

Größe	d1 mm	inch	l4 mm	b mm	h mm	Code-Nr.
160	16,000		3,000	7,000	11,000	16,000
160	16,270	41/64	3,000	7,000	11,000	16,270
165	16,500		3,100	7,000	11,000	16,500
165	16,670	21/32	3,100	7,000	11,000	16,670
170	17,000		3,100	7,000	11,000	17,000
170	17,070	43/64	3,200	7,000	11,000	17,070
170	17,460	11/16	3,200	7,000	11,000	17,460
175	17,500		3,200	7,000	11,000	17,500
175	17,600		3,300	7,000	11,000	17,600
175	17,860	45/64	3,300	7,000	11,000	17,860
180	18,000		3,300	8,000	12,600	18,000
180	18,260	23/32	3,400	8,000	12,600	18,260
185	18,500		3,400	8,000	12,600	18,500
185	18,650	47/64	3,400	8,000	12,600	18,650
190	19,000		3,500	8,000	12,600	19,000
190	19,050	3/4	3,500	8,000	12,600	19,050
190	19,450	49/64	3,600	8,000	12,600	19,450
195	19,500		3,600	8,000	12,600	19,500
195	19,600		3,600	8,000	12,600	19,600
195	19,840	25/32	3,700	8,000	12,600	19,840
200	20,000		3,700	9,000	13,900	20,000
200	20,240	51/64	3,700	9,000	13,900	20,240
205	20,500		3,800	9,000	13,900	20,500
205	20,640	13/16	3,800	9,000	13,900	20,640
210	21,000		3,900	9,000	13,900	21,000
210	21,030	53/64	3,900	9,000	13,900	21,030
210	21,100		3,900	9,000	13,900	21,100
210	21,430	27/32	3,900	9,000	13,900	21,430
215	21,500		4,000	9,000	13,900	21,500
215	21,830	55/64	4,000	9,000	13,900	21,830
220	22,000		4,100	10,000	15,300	22,000
220	22,220	7/8	4,100	10,000	15,300	22,220
225	22,500		4,100	10,000	15,300	22,500
225	22,620	57/64	4,200	10,000	15,300	22,620
230	23,000		4,200	10,000	15,300	23,000
230	23,020	29/32	4,200	10,000	15,300	23,020
230	23,420	59/64	4,300	10,000	15,300	23,420
235	23,500		4,300	10,000	15,300	23,500
235	23,810	15/16	4,400	10,000	15,300	23,810
240	24,000		4,400	11,000	15,800	24,000
240	24,100		4,400	11,000	15,800	24,100
240	24,210	61/64	4,500	11,000	15,800	24,210
245	24,500		4,500	11,000	15,800	24,500
245	24,610	31/32	4,500	11,000	15,800	24,610
250	25,000	63/64	4,600	11,000	15,800	25,000
250	25,400	1	4,700	11,000	15,800	25,400
255	25,500		4,700	11,000	15,800	25,500
255	25,670		4,700	11,000	15,800	25,670
255	25,700		4,700	11,000	15,800	25,700
260	26,000		4,800	12,000	20,000	26,000
260	26,190	1 1/32	4,800	12,000	20,000	26,190
265	26,500		4,900	12,000	20,000	26,500
265	26,590	1 3/64	4,900	12,000	20,000	26,590
270	27,000		5,000	12,000	20,000	27,000
275	27,500		5,100	12,000	20,000	27,500
275	27,700		5,100	12,000	20,000	27,700
275	27,780	1 3/32	5,100	12,000	20,000	27,780
280	28,000		5,100	13,000	20,700	28,000
280	28,180	1 7/64	5,200	13,000	20,700	28,180
285	28,500		5,200	13,000	20,700	28,500
285	28,580		5,300	13,000	20,700	28,580
290	29,000		5,300	13,000	20,700	29,000
290	29,370	1 5/32	5,400	13,000	20,700	29,370
295	29,500		5,400	13,000	20,700	29,500
295	29,600		5,400	13,000	20,700	29,600
295	29,770	1 11/64	5,500	13,000	20,700	29,770
300	30,000		5,500	14,000	22,300	30,000
300	30,160	1 3/16	5,500	14,000	22,300	30,160
305	30,500		5,600	14,000	22,300	30,500
305	30,960	1 7/32	5,700	14,000	22,300	30,960
310	31,000		5,700	14,000	22,300	31,000
315	31,500		5,800	14,000	22,300	31,500



Multiplex HPC-Wechselplatten

Größe	d1 mm	inch	l4 mm	b mm	h mm	Code-Nr.
315	31,750	1 1/4	5,800	14,000	22,300	31,750
320	32,000		5,900	15,000	23,100	32,000
320	32,500		6,000	15,000	23,100	32,500
320	32,540	1 9/32	6,000	15,000	23,100	32,540
320	32,940	1 19/64	6,000	15,000	23,100	32,940
330	33,000		6,100	15,000	23,100	33,000
330	33,340	1 5/16	6,100	15,000	23,100	33,340
330	33,500		6,100	15,000	23,100	33,500
340	34,000		6,200	15,000	23,100	34,000
340	34,130	1 11/32	6,300	15,000	23,100	34,130
340	34,500		6,300	15,000	23,100	34,500
340	34,930		6,400	15,000	23,100	34,930
350	35,000		6,400	15,000	23,100	35,000
350	35,500		6,500	15,000	23,100	35,500
350	35,720	1 13/32	6,600	15,000	23,100	35,720
360	36,000		6,600	16,000	23,900	36,000
360	36,500		6,700	16,000	23,900	36,500
360	36,510	1 7/16	6,700	16,000	23,900	36,510
370	37,000		6,800	16,000	23,900	37,000
370	37,310	1 15/32	6,800	16,000	23,900	37,310
370	37,500		6,900	16,000	23,900	37,500
380	38,000		7,000	16,000	23,900	38,000
380	38,100	1 1/2	7,000	16,000	23,900	38,100
380	38,500	1 33/64	7,100	16,000	23,900	38,500
390	39,000		7,100	16,000	23,900	39,000
390	39,500		7,200	16,000	23,900	39,500
400	40,000		7,300	16,000	23,900	40,000



ANWENDUNGSBEISPIEL VA-FLANSCH

Werkzeug-Typ	Multiplex HPC
Artikel-Nr. WP	86725
Artikel-Nr. Halter	86684
Durchmesser	17 mm
Bohrtiefe	90 mm
Material	X6CrNiMoTi 17-12-2
Kühlung	IK 40 bar
Schmierstoff	Emulsion
Maschine	BAZ
v_c	40 m/min
f	0,15 mm/U
Standweg	22,5 m



Multiplex HPC-Wechselplatten

Artikel-Nr. 86723



P	M	K	N	S	H
○		●			



Ausspitzung $\geq \varnothing 11,000$ • Flächenanschliff • Hauptschneidenform gerade (durch Korrektur) • Spanschrauben Art.-Nr. 86843 enthalten
 Vermikularguss GGv • Grauguss, Temperguss, Sphäroguss

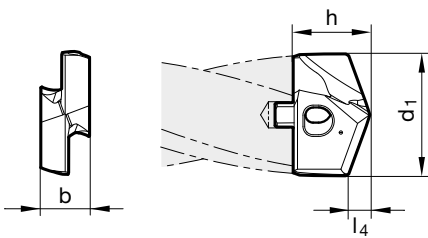

Größe	d1 mm	inch	l4 mm	b mm	h mm	Code-Nr.
110	11,000		2,600	4,500	7,500	11,000
110	11,200		2,600	4,500	7,500	11,200
115	11,500		2,700	4,500	7,500	11,500
115	11,510	29/64	2,700	4,500	7,500	11,510
115	11,700		2,700	4,500	7,500	11,700
115	11,800		2,700	4,500	7,500	11,800
115	11,910	15/32	2,700	4,500	7,500	11,910
120	12,000		2,900	5,000	7,700	12,000
120	12,100		2,900	5,000	7,700	12,100
120	12,200		2,900	5,000	7,700	12,200
120	12,300	31/64	2,900	5,000	7,700	12,300
125	12,500		3,000	5,000	7,700	12,500
125	12,600		3,000	5,000	7,700	12,600
125	12,700	1/2	3,000	5,000	7,700	12,700
125	12,800		3,000	5,000	7,700	12,800
125	12,900		3,000	5,000	7,700	12,900
130	13,000		3,100	5,500	8,500	13,000
130	13,100	33/64	3,100	5,500	8,500	13,100
130	13,490	17/32	3,100	5,500	8,500	13,490
135	13,500		3,300	5,500	8,500	13,500
135	13,600		3,300	5,500	8,500	13,600
135	13,700		3,300	5,500	8,500	13,700
135	13,800		3,300	5,500	8,500	13,800
135	13,890	35/64	3,300	5,500	8,500	13,890
140	14,000		3,400	6,000	9,600	14,000
140	14,100		3,400	6,000	9,600	14,100
140	14,290	9/16	3,400	6,000	9,600	14,290
140	14,400		3,400	6,000	9,600	14,400
145	14,500		3,500	6,000	9,600	14,500
145	14,600		3,500	6,000	9,600	14,600
145	14,680	37/64	3,500	6,000	9,600	14,680
145	14,700		3,500	6,000	9,600	14,700
145	14,800		3,500	6,000	9,600	14,800
150	15,000		3,600	6,000	9,800	15,000
150	15,080	19/32	3,600	6,000	9,800	15,080
150	15,100		3,600	6,000	9,800	15,100
150	15,200		3,600	6,000	9,800	15,200
150	15,300		3,600	6,000	9,800	15,300
150	15,480	39/64	3,600	6,000	9,800	15,480
155	15,500		3,800	6,000	9,800	15,500
155	15,600		3,800	6,000	9,800	15,600
155	15,700		3,800	6,000	9,800	15,700



Multiplex HPC-Wechselplatten

Größe	d1 mm	inch	l4 mm	b mm	h mm	Code-Nr.
155	15,800		3,800	6,000	9,800	15,800
155	15,870	5/8	3,800	6,000	9,800	15,870
160	16,000		3,800	7,000	11,000	16,000
160	16,270	41/64	3,800	7,000	11,000	16,270
165	16,500		4,000	7,000	11,000	16,500
165	16,670	21/32	4,000	7,000	11,000	16,670
170	17,000		4,100	7,000	11,000	17,000
170	17,070	43/64	4,100	7,000	11,000	17,070
170	17,460	11/16	4,100	7,000	11,000	17,460
175	17,500		4,200	7,000	11,000	17,500
175	17,600		4,200	7,000	11,000	17,600
175	17,860	45/64	4,200	7,000	11,000	17,860
180	18,000		4,300	8,000	12,600	18,000
180	18,260	23/32	4,300	8,000	12,600	18,260
185	18,500		4,400	8,000	12,600	18,500
185	18,650	47/64	4,400	8,000	12,600	18,650
190	19,000		4,600	8,000	12,600	19,000
190	19,050	3/4	4,600	8,000	12,600	19,050
190	19,250		4,600	8,000	12,600	19,250
190	19,450	49/64	4,600	8,000	12,600	19,450
195	19,500		4,700	8,000	12,600	19,500
195	19,600		4,700	8,000	12,600	19,600
195	19,840	25/32	4,700	8,000	12,600	19,840
200	20,000		4,800	9,000	13,900	20,000
200	20,240	51/64	4,800	9,000	13,900	20,240
205	20,500		5,000	9,000	13,900	20,500
205	20,640	13/16	5,000	9,000	13,900	20,640
210	21,000		5,100	9,000	13,900	21,000
210	21,030	53/64	5,100	9,000	13,900	21,030
210	21,100		5,100	9,000	13,900	21,100
210	21,430	27/32	5,100	9,000	13,900	21,430
215	21,500		5,200	9,000	13,900	21,500
215	21,830	55/64	5,200	9,000	13,900	21,830
220	22,000		5,300	10,000	15,300	22,000
220	22,220	7/8	5,300	10,000	15,300	22,220
225	22,500		5,400	10,000	15,300	22,500
225	22,620	57/64	5,400	10,000	15,300	22,620
230	23,000		5,600	10,000	15,300	23,000
230	23,020	29/32	5,600	10,000	15,300	23,020
230	23,420	59/64	5,600	10,000	15,300	23,420
235	23,500		5,700	10,000	15,300	23,500
235	23,810	15/16	5,700	10,000	15,300	23,810
240	24,000		5,800	11,000	15,800	24,000
240	24,100		5,800	11,000	15,800	24,100
240	24,210	61/64	5,800	11,000	15,800	24,210
245	24,500		6,000	11,000	15,800	24,500
245	24,610	31/32	6,000	11,000	15,800	24,610
250	25,000	63/64	6,100	11,000	15,800	25,000
250	25,400	1	6,100	11,000	15,800	25,400
255	25,500		6,200	11,000	15,800	25,500
255	25,670		6,200	11,000	15,800	25,670
255	25,700		6,200	11,000	15,800	25,700
255	25,810		6,200	11,000	15,800	25,810
260	26,000		6,000	12,000	20,000	26,000
260	26,190	1 1/32	6,000	12,000	20,000	26,190
265	26,500		6,100	12,000	20,000	26,500
265	26,590	1 3/64	6,100	12,000	20,000	26,590
270	27,000		6,300	12,000	20,000	27,000
275	27,500		6,400	12,000	20,000	27,500
275	27,700		6,400	12,000	20,000	27,700
275	27,780	1 3/32	6,400	12,000	20,000	27,780
280	28,000		6,600	13,000	20,700	28,000
280	28,180	1 7/64	6,600	13,000	20,700	28,180
285	28,500		6,700	13,000	20,700	28,500
285	28,580		6,700	13,000	20,700	28,580
290	29,000		6,900	13,000	20,700	29,000
290	29,370	1 5/32	6,900	13,000	20,700	29,370
295	29,500		7,000	13,000	20,700	29,500
295	29,770	1 11/64	7,000	13,000	20,700	29,770
300	30,000		6,900	14,000	22,300	30,000
300	30,160	1 3/16	6,900	14,000	22,300	30,160
305	30,500		7,000	14,000	22,300	30,500



Multiplex HPC-Wechselplatten

Größe	d1 mm	inch	l4 mm	b mm	h mm	Code-Nr.
305	30,960	1 7/32	7,000	14,000	22,300	30,960
310	31,000		7,200	14,000	22,300	31,000
315	31,500		7,300	14,000	22,300	31,500
315	31,750	1 1/4	7,300	14,000	22,300	31,750
320	32,000		7,500	15,000	23,100	32,000
320	32,500		7,600	15,000	23,100	32,500
320	32,540	1 9/32	7,600	15,000	23,100	32,540
320	32,940	1 19/64	7,600	15,000	23,100	32,940
330	33,000		7,800	15,000	23,100	33,000
330	33,340	1 5/16	7,800	15,000	23,100	33,340
330	33,500		7,900	15,000	23,100	33,500
340	34,000		8,100	15,000	23,100	34,000
340	34,130	1 11/32	8,100	15,000	23,100	34,130
340	34,500		8,200	15,000	23,100	34,500
340	34,930		8,200	15,000	23,100	34,930
350	35,000		8,300	15,000	23,100	35,000
350	35,500		8,400	15,000	23,100	35,500
350	35,720	1 13/32	8,400	15,000	23,100	35,720
360	36,000		8,500	16,000	23,900	36,000
360	36,500		8,600	16,000	23,900	36,500
360	36,510	1 7/16	8,600	16,000	23,900	36,510
370	37,000		8,800	16,000	23,900	37,000
370	37,310	1 15/32	8,800	16,000	23,900	37,310
370	37,500		8,900	16,000	23,900	37,500
380	38,000		9,000	16,000	23,900	38,000
380	38,100	1 1/2	9,000	16,000	23,900	38,100
380	38,500	1 33/64	9,100	16,000	23,900	38,500
390	39,000		9,300	16,000	23,900	39,000
390	39,500		9,400	16,000	23,900	39,500
400	40,000		9,400	16,000	23,900	40,000



ANWENDUNGSBEISPIEL GUSS-GEHÄUSE

Werkzeug-Typ	Multiplex HPC
Artikel-Nr. WP	86723
Artikel-Nr. Halter	86684
Durchmesser	22 mm
Bohrtiefe	110 mm
Material	EN-GJL-250
Kühlung	IK 60 bar
Schmierstoff	Emulsion
Maschine	BAZ
v_c	90 m/min
f	0,5 mm/U
Standweg	350 m



Multiplex HPC-Wechselplatten

Artikel-Nr. 86724



P	M	K	N	S	H
			•		



Ausspitzung $\geq \text{Ø } 11,000$ • Kegelmantelschliff • Spannschrauben Art.-Nr. 86843 enthalten • Hauptschneidenform konkav
 Aluminium und Al-Legierungen • NE-Metalle

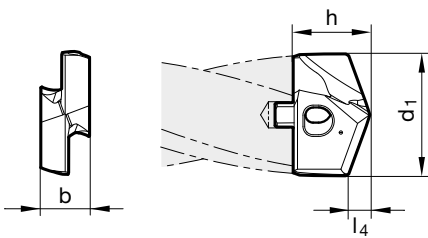

Größe	d1 mm	inch	l4 mm	b mm	h mm	Code-Nr.
110	11,000		2,100	4,500	7,500	11,000
110	11,200		2,100	4,500	7,500	11,200
115	11,500		2,100	4,500	7,500	11,500
115	11,510	29/64	2,100	4,500	7,500	11,510
115	11,700		2,200	4,500	7,500	11,700
115	11,800		2,200	4,500	7,500	11,800
115	11,910	15/32	2,200	4,500	7,500	11,910
120	12,000		2,200	5,000	7,700	12,000
120	12,100		2,300	5,000	7,700	12,100
120	12,200		2,300	5,000	7,700	12,200
120	12,300	31/64	2,300	5,000	7,700	12,300
125	12,500		2,300	5,000	7,700	12,500
125	12,600		2,300	5,000	7,700	12,600
125	12,700	1/2	2,400	5,000	7,700	12,700
125	12,800		2,400	5,000	7,700	12,800
125	12,900		2,400	5,000	7,700	12,900
130	13,000		2,400	5,500	8,500	13,000
130	13,100	33/64	2,400	5,500	8,500	13,100
130	13,490	17/32	2,500	5,500	8,500	13,490
135	13,500		2,500	5,500	8,500	13,500
135	13,600		2,500	5,500	8,500	13,600
135	13,700		2,500	5,500	8,500	13,700
135	13,800		2,600	5,500	8,500	13,800
135	13,890	35/64	2,600	5,500	8,500	13,890
140	14,000		2,600	6,000	9,600	14,000
140	14,100		2,600	6,000	9,600	14,100
140	14,290	9/16	2,700	6,000	9,600	14,290
140	14,400		2,700	6,000	9,600	14,400
145	14,500		2,700	6,000	9,600	14,500
145	14,600		2,700	6,000	9,600	14,600
145	14,680	37/64	2,700	6,000	9,600	14,680
145	14,700		2,700	6,000	9,600	14,700
145	14,800		2,700	6,000	9,600	14,800
150	15,000		2,800	6,000	9,800	15,000
150	15,080	19/32	2,800	6,000	9,800	15,080
150	15,100		2,800	6,000	9,800	15,100
150	15,200		2,800	6,000	9,800	15,200
150	15,300		2,800	6,000	9,800	15,300
150	15,480	39/64	2,900	6,000	9,800	15,480
155	15,500		2,900	6,000	9,800	15,500
155	15,600		2,900	6,000	9,800	15,600
155	15,700		2,900	6,000	9,800	15,700



Multiplex HPC-Wechselplatten

Größe	d1 mm	inch	l4 mm	b mm	h mm	Code-Nr.
155	15,800		2,900	6,000	9,800	15,800
155	15,870	5/8	2,900	6,000	9,800	15,870
160	16,000		3,000	7,000	11,000	16,000
160	16,270	41/64	3,000	7,000	11,000	16,270
165	16,500		3,100	7,000	11,000	16,500
165	16,670	21/32	3,100	7,000	11,000	16,670
170	17,000		3,100	7,000	11,000	17,000
170	17,070	43/64	3,200	7,000	11,000	17,070
170	17,460	11/16	3,200	7,000	11,000	17,460
175	17,500		3,200	7,000	11,000	17,500
175	17,600		3,300	7,000	11,000	17,600
175	17,860	45/64	3,300	7,000	11,000	17,860
180	18,000		3,300	8,000	12,600	18,000
180	18,260	23/32	3,400	8,000	12,600	18,260
185	18,500		3,400	8,000	12,600	18,500
185	18,650	47/64	3,400	8,000	12,600	18,650
190	19,000		3,500	8,000	12,600	19,000
190	19,050	3/4	3,500	8,000	12,600	19,050
190	19,250		3,600	8,000	12,600	19,250
190	19,450	49/64	3,600	8,000	12,600	19,450
195	19,500		3,600	8,000	12,600	19,500
195	19,600		3,600	8,000	12,600	19,600
195	19,840	25/32	3,700	8,000	12,600	19,840
200	20,000		3,700	9,000	13,900	20,000
200	20,240	51/64	3,700	9,000	13,900	20,240
205	20,500		3,800	9,000	13,900	20,500
205	20,640	13/16	3,800	9,000	13,900	20,640
210	21,000		3,900	9,000	13,900	21,000
210	21,030	53/64	3,900	9,000	13,900	21,030
210	21,100		3,900	9,000	13,900	21,100
210	21,430	27/32	3,900	9,000	13,900	21,430
215	21,500		4,000	9,000	13,900	21,500
215	21,830	55/64	4,000	9,000	13,900	21,830
220	22,000		4,100	10,000	15,300	22,000
220	22,220	7/8	4,100	10,000	15,300	22,220
225	22,500		4,100	10,000	15,300	22,500
225	22,620	57/64	4,200	10,000	15,300	22,620
230	23,000		4,200	10,000	15,300	23,000
230	23,020	29/32	4,200	10,000	15,300	23,020
230	23,420	59/64	4,300	10,000	15,300	23,420
235	23,500		4,300	10,000	15,300	23,500
235	23,810	15/16	4,400	10,000	15,300	23,810
240	24,000		4,400	11,000	15,800	24,000
240	24,100		4,400	11,000	15,800	24,100
240	24,210	61/64	4,500	11,000	15,800	24,210
245	24,500		4,500	11,000	15,800	24,500
245	24,610	31/32	4,500	11,000	15,800	24,610
250	25,000	63/64	4,600	11,000	15,800	25,000
250	25,400	1	4,700	11,000	15,800	25,400
255	25,500		4,700	11,000	15,800	25,500
255	25,670		4,700	11,000	15,800	25,670
255	25,700		4,700	11,000	15,800	25,700
255	25,810		4,700	11,000	15,800	25,810
260	26,000		4,800	12,000	20,000	26,000
260	26,190	1 1/32	4,800	12,000	20,000	26,190
265	26,500		4,900	12,000	20,000	26,500
265	26,590	1 3/64	4,900	12,000	20,000	26,590
270	27,000		5,000	12,000	20,000	27,000
275	27,500		5,100	12,000	20,000	27,500
275	27,700		5,100	12,000	20,000	27,700
275	27,780	1 3/32	5,100	12,000	20,000	27,780
280	28,000		5,100	13,000	20,700	28,000
280	28,180	1 7/64	5,200	13,000	20,700	28,180
285	28,500		5,200	13,000	20,700	28,500
285	28,580		5,300	13,000	20,700	28,580
290	29,000		5,300	13,000	20,700	29,000
290	29,370	1 5/32	5,400	13,000	20,700	29,370
295	29,500		5,400	13,000	20,700	29,500
295	29,770	1 11/64	5,500	13,000	20,700	29,770
300	30,000		5,500	14,000	22,300	30,000
300	30,160	1 3/16	5,500	14,000	22,300	30,160
305	30,500		5,600	14,000	22,300	30,500



Multiplex HPC-Wechselplatten

Größe	d1 mm	inch	l4 mm	b mm	h mm	Code-Nr.
305	30,960	1 7/32	5,700	14,000	22,300	30,960
310	31,000		5,700	14,000	22,300	31,000
315	31,500		5,800	14,000	22,300	31,500
315	31,750	1 1/4	5,800	14,000	22,300	31,750
320	32,000		5,900	15,000	23,100	32,000
320	32,500		6,000	15,000	23,100	32,500
320	32,540	1 9/32	6,000	15,000	23,100	32,540
320	32,940	1 19/64	6,000	15,000	23,100	32,940
330	33,000		6,100	15,000	23,100	33,000
330	33,340	1 5/16	6,100	15,000	23,100	33,340
330	33,500		6,100	15,000	23,100	33,500
340	34,000		6,200	15,000	23,100	34,000
340	34,130	1 11/32	6,300	15,000	23,100	34,130
340	34,500		6,300	15,000	23,100	34,500
340	34,930		6,400	15,000	23,100	34,930
350	35,000		6,400	15,000	23,100	35,000
350	35,500		6,500	15,000	23,100	35,500
350	35,720	1 13/32	6,600	15,000	23,100	35,720
360	36,000		6,600	16,000	23,900	36,000
360	36,500		6,700	16,000	23,900	36,500
360	36,510	1 7/16	6,700	16,000	23,900	36,510
370	37,000		6,800	16,000	23,900	37,000
370	37,310	1 15/32	6,800	16,000	23,900	37,310
370	37,500		6,900	16,000	23,900	37,500
380	38,000		7,000	16,000	23,900	38,000
380	38,100	1 1/2	7,000	16,000	23,900	38,100
380	38,500	1 33/64	7,100	16,000	23,900	38,500
390	39,000		7,100	16,000	23,900	39,000
390	39,500		7,200	16,000	23,900	39,500
400	40,000		7,300	16,000	23,900	40,000



ANWENDUNGSBEISPIEL ALUFELGE

Werkzeug-Typ	Multiplex HPC
Artikel-Nr. WP	86724
Artikel-Nr. Halter	86685
Durchmesser	13 mm
Bohrtiefe	90 mm
Material	G-AlSi7
Kühlung	IK 40 bar
Schmierstoff	Emulsion
Maschine	BAZ
v_c	140 m/min
f	0,25 mm/U
Standweg	300 m



Multiplex HPC-Wechselplatten

Artikel-Nr. 86721



P	M	K	N	S	H
○	○	○	○	○	○



Ausspitzung $\geq \varnothing 11,000$ • Flächenanschliff • Hauptschneidenform gerade (durch Korrektur) • Spanschrauben Art.-Nr. 86843 enthalten
 Pilotieren in allen Werkstoffen

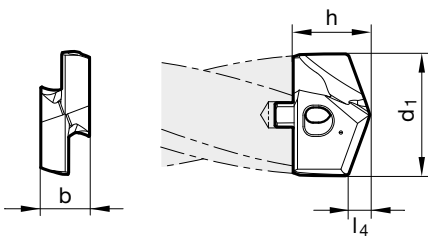

Größe	d1 mm	inch	l4 mm	b mm	h mm	Code-Nr.
110	11,000		1,800	4,500	7,200	11,000
110	11,200		1,800	4,500	7,200	11,200
110	11,500		1,900	4,500	7,200	11,500
110	11,510	29/64	1,900	4,500	7,200	11,510
110	11,700		1,900	4,500	7,200	11,700
110	11,800		1,900	4,500	7,200	11,800
110	11,910	15/32	1,900	4,500	7,200	11,910
120	12,000		1,900	5,000	7,400	12,000
120	12,100		2,000	5,000	7,400	12,100
120	12,200		2,000	5,000	7,400	12,200
120	12,300	31/64	2,000	5,000	7,400	12,300
120	12,500		2,000	5,000	7,400	12,500
120	12,600		2,000	5,000	7,400	12,600
120	12,700	1/2	2,100	5,000	7,400	12,700
120	12,800		2,100	5,000	7,400	12,800
120	12,900		2,100	5,000	7,400	12,900
130	13,000		2,100	5,500	8,200	13,000
130	13,100	33/64	2,100	5,500	8,200	13,100
130	13,490	17/32	2,200	5,500	8,200	13,490
130	13,500		2,200	5,500	8,200	13,500
130	13,600		2,200	5,500	8,200	13,600
130	13,700		2,200	5,500	8,200	13,700
130	13,800		2,200	5,500	8,200	13,800
130	13,890	35/64	2,200	5,500	8,200	13,890
140	14,000		2,300	6,000	9,400	14,000
140	14,100		2,300	6,000	9,400	14,100
140	14,290	9/16	2,300	6,000	9,400	14,290
140	14,400		2,300	6,000	9,400	14,400
140	14,500		2,300	6,000	9,400	14,500
140	14,600		2,400	6,000	9,400	14,600
140	14,680	37/64	2,400	6,000	9,400	14,680
140	14,700		2,400	6,000	9,400	14,700
140	14,800		2,400	6,000	9,400	14,800
140	15,000		2,400	6,000	9,400	15,000
140	15,080	19/32	2,400	6,000	9,400	15,080
140	15,100		2,400	6,000	9,400	15,100
140	15,200		2,400	6,000	9,400	15,200
140	15,300		2,500	6,000	9,400	15,300
140	15,480	39/64	2,500	6,000	9,400	15,480
140	15,500		2,500	6,000	9,400	15,500
140	15,600		2,500	6,000	9,400	15,600
140	15,700		2,500	6,000	9,400	15,700



Multiplex HPC-Wechselplatten

Größe	d1 mm	inch	l4 mm	b mm	h mm	Code-Nr.
140	15,800		2,500	6,000	9,400	15,800
140	15,870	5/8	2,600	6,000	9,400	15,870
160	16,000		2,600	7,000	10,600	16,000
160	16,270	41/64	2,600	7,000	10,600	16,270
160	16,500		2,700	7,000	10,600	16,500
160	16,670	21/32	2,700	7,000	10,600	16,670
160	17,000		2,700	7,000	10,600	17,000
160	17,070	43/64	2,700	7,000	10,600	17,070
160	17,460	11/16	2,800	7,000	10,600	17,460
160	17,500		2,800	7,000	10,600	17,500
160	17,600		2,800	7,000	10,600	17,600
160	17,860	45/64	2,900	7,000	10,600	17,860
180	18,000		2,900	8,000	12,100	18,000
180	18,260	23/32	2,900	8,000	12,100	18,260
180	18,500		3,000	8,000	12,100	18,500
180	18,650	47/64	3,000	8,000	12,100	18,650
180	19,000		3,000	8,000	12,100	19,000
180	19,050	3/4	3,100	8,000	12,100	19,050
180	19,450	49/64	3,100	8,000	12,100	19,450
180	19,500		3,100	8,000	12,100	19,500
180	19,600		3,100	8,000	12,100	19,600
180	19,840	25/32	3,200	8,000	12,100	19,840
200	20,000		3,200	9,000	13,300	20,000
200	20,240	51/64	3,200	9,000	13,300	20,240
200	20,500		3,300	9,000	13,300	20,500
200	20,640	13/16	3,300	9,000	13,300	20,640
200	21,000		3,400	9,000	13,300	21,000
200	21,030	53/64	3,400	9,000	13,300	21,030
200	21,100		3,400	9,000	13,300	21,100
200	21,430	27/32	3,400	9,000	13,300	21,430
200	21,500		3,400	9,000	13,300	21,500
200	21,830	55/64	3,500	9,000	13,300	21,830
220	22,000		3,500	10,000	14,800	22,000
220	22,220	7/8	3,600	10,000	14,800	22,220
220	22,500		3,600	10,000	14,800	22,500
220	22,620	57/64	3,600	10,000	14,800	22,620
220	23,000		3,700	10,000	14,800	23,000
220	23,020	29/32	3,700	10,000	14,800	23,020
220	23,420	59/64	3,700	10,000	14,800	23,420
220	23,500		3,800	10,000	14,800	23,500
220	23,810	15/16	3,800	10,000	14,800	23,810
240	24,000		3,800	11,000	15,300	24,000
240	24,100		3,800	11,000	15,300	24,100
240	24,210	61/64	3,900	11,000	15,300	24,210
240	24,500		3,900	11,000	15,300	24,500
240	24,610	31/32	3,900	11,000	15,300	24,610
240	25,000	63/64	4,000	11,000	15,300	25,000
240	25,400	1	4,100	11,000	15,300	25,400
240	25,500		4,100	11,000	15,300	25,500
240	25,700		4,100	11,000	15,300	25,700
260	26,000		4,100	12,000	19,400	26,000
260	26,190	1 1/32	4,200	12,000	19,400	26,190
260	26,500		4,200	12,000	19,400	26,500
260	26,590	1 3/64	4,200	12,000	19,400	26,590
260	27,000		4,300	12,000	19,400	27,000
260	27,500		4,400	12,000	19,400	27,500
260	27,700		4,400	12,000	19,400	27,700
260	27,780	1 3/32	4,400	12,000	19,400	27,780
280	28,000		4,500	13,000	20,100	28,000
280	28,180	1 7/64	4,500	13,000	20,100	28,180
280	28,500		4,500	13,000	20,100	28,500
280	28,580		4,600	13,000	20,100	28,580
280	29,000		4,600	13,000	20,100	29,000
280	29,370	1 5/32	4,700	13,000	20,100	29,370
280	29,500		4,700	13,000	20,100	29,500
300	30,000		4,800	14,000	21,700	30,000
300	30,160	1 3/16	4,800	14,000	21,700	30,160
300	30,500		4,900	14,000	21,700	30,500
300	30,960	1 7/32	4,900	14,000	21,700	30,960
300	31,000		4,900	14,000	21,700	31,000
300	31,500		5,000	14,000	21,700	31,500
300	31,750	1 1/4	5,100	14,000	21,700	31,750



Multiplex HPC-Wechselplatten

Größe	d1 mm	inch	l4 mm	b mm	h mm	Code-Nr.
320	32,000		5,100	15,000	22,400	32,000
320	32,500		5,200	15,000	22,400	32,500
320	32,540	1 9/32	5,200	15,000	22,400	32,540
320	33,000		5,300	15,000	22,400	33,000
320	33,340	1 5/16	5,300	15,000	22,400	33,340
320	33,500		5,300	15,000	22,400	33,500
320	34,000		5,400	15,000	22,400	34,000
320	34,130	1 11/32	5,400	15,000	22,400	34,130
320	34,500		5,500	15,000	22,400	34,500
320	34,930		5,600	15,000	22,400	34,930
320	35,000		5,600	15,000	22,400	35,000
320	35,500		5,600	15,000	22,400	35,500
320	35,720	1 13/32	5,700	15,000	22,400	35,720
360	36,000		5,700	16,000	23,200	36,000
360	36,500		5,800	16,000	23,200	36,500
360	36,510	1 7/16	5,800	16,000	23,200	36,510
360	37,000		5,900	16,000	23,200	37,000
360	37,310	1 15/32	5,900	16,000	23,200	37,310
360	37,500		6,000	16,000	23,200	37,500
360	38,000		6,000	16,000	23,200	38,000
360	38,100	1 1/2	6,100	16,000	23,200	38,100
360	38,500	1 33/64	6,100	16,000	23,200	38,500
360	39,000		6,200	16,000	23,200	39,000
360	39,500		6,300	16,000	23,200	39,500
360	40,000		6,400	16,000	23,200	40,000



PILOTIERPLATTE ARTIKEL-NR. 86721

Spezialauspitzung für exaktes Anbohren

Doppelfase garantiert präzise Bohrungen

145°-Spitzenwinkel und die m7-Ø-Toleranz erzeugen perfekte Verhältnisse für die nachfolgende Bohrplatte

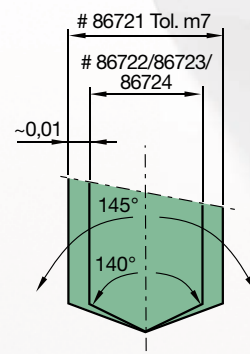



Multiplex HPC-Wechselplatten

Artikel-Nr. 86729



P	M	K	N	S	H
•					



Flächenanschliff • Hauptschneidenform konkav • spezieller Spitzenanschliff mit 160° Spitzenwinkel und 125° Zentrierspitze
 • Spannschrauben Art.-Nr. 86843 enthalten

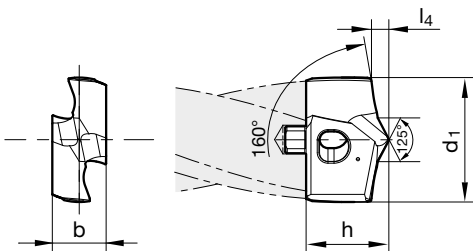

Größe	d1 mm	inch	l4 mm	b mm	h mm	Code-Nr.
120	12,000		1,700	5,000	7,500	12,000
140	14,000		2,000	6,000	9,500	14,000
160	16,000		2,300	7,000	10,800	16,000
180	18,000		2,600	8,000	12,300	18,000
200	20,000		2,900	9,000	13,600	20,000
210	21,000		3,000	9,000	13,600	21,000
220	22,000		3,200	10,000	14,900	22,000
240	24,000		3,500	11,000	15,500	24,000
250	25,000	63/64	3,600	11,000	15,500	25,000
260	26,000		3,800	12,000	18,500	26,000
270	27,000		3,900	12,000	18,600	27,000
280	28,000		4,100	13,000	18,600	28,000
290	29,000		4,200	13,000	18,600	29,000
300	30,000		4,400	14,000	19,900	30,000
320	32,000		4,600	15,000	21,300	32,000
330	33,000		4,800	15,000	21,700	33,000
340	34,000		4,900	15,000	22,200	34,000
360	36,000		5,200	16,000	22,500	36,000
380	38,000		5,500	16,000	23,000	38,000
400	40,000		5,800	16,000	23,100	40,000

MULTIPLIX HPC-WENDESCHNEIDPLATTEN FÜR DIE BEARBEITUNG VON STAHLTRÄGERN

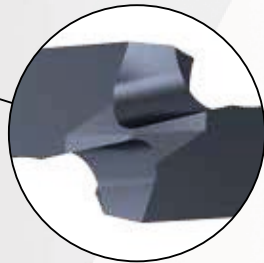

Die Spitzegeometrie der neuen Wendeschneidplatten sorgt für optimale Zentriereigenschaften und kompensiert dadurch die instabilen Bearbeitungsverhältnisse bei der Stahlträgerfertigung.

- ▼ neue Wendeschneidplatten speziell für die Stahlträgerbearbeitung
- ▼ reduzierte Gratbildung
- ▼ optimale Zentriereigenschaften
- ▼ ruhiges Bohrverhalten
- ▼ insbesondere für die Bearbeitung auf Bohrsäge- und Bohrbrennanlagen



Minimierte Gratbildung durch hohen Spitzenwinkel im äußeren Bereich.



Multiplex HPC-Senkplatten

Artikel-Nr. 86728



P	M	K	N	S	H
•	○	○		○	○



Stahl und Stahlguss (legiert und unleg.)

ISO	Halter-Größe	Code-Nr.
CPGT050202F R-P	110-140	52,020
CPGT050204F R-P	110-140	52,040
CPGT060202F R-P	160-280	62,020
CPGT060204F R-P	160-280	62,040
CPGT09T308F R-P	300-360	93,080



Multiplex HPC-Senkplatten

Artikel-Nr. 86726



P	M	K	N	S	H
○		●			



Grauguss, Temperguss, Sphäroguss

ISO	Halter-Größe	Code-Nr.
CPGW050202F N-K	110-140	52,020
CPGW050204F N-K	110-140	52,040
CPGW060202F N-K	160-280	62,020
CPGW060204F N-K	160-280	62,040
CPGW09T308F N-K	300-360	93,080



Multiplex HPC-Senkplatten

Artikel-Nr. 86727



P	M	K	N	S	H
			•		



Aluminium und Al-Legierungen • NE-Metalle

ISO	Halter-Größe	Code-Nr.
CPGT050202F R-AL	110-140	52,020
CPGT050204F R-AL	110-140	52,040
CPGT060202F R-AL	160-280	62,020
CPGT060204F R-AL	160-280	62,040
CPGT09T308F R-AL	300-360	93,080



Spannschrauben für Multiplex HPC-Senkhalter

Artikel-Nr. 86846



Anzugsmomente Torxschrauben s. „Multiplex HPC - Technik und Vorteile“

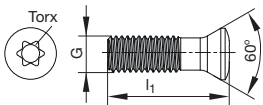

G	l1 mm	Torx	Code-Nr.
M 2,0X5,50	5,500	T6	2,000
M 2,0X5,30	5,300	T7	2,500
M 4 X9,50	9,500	T15	4,006



Spannschrauben für Multiplex HPC-Halter 1,5-10xD

Artikel-Nr. 86843



Anzugsmomente Torxschrauben s. „Multiplex HPC - Technik und Vorteile“

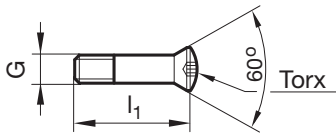

G	l1 mm	Torx	Code-Nr.
M2,2	9,500	T7	2,200
M2,2	10,500	T7	2,201
M2,5	11,400	T8	2,500
M3	12,100	T9	3,000
M3	13,100	T9	3,001
M3,5	14,250	T10	3,500
M4	16,000	T15	4,000
M4,5	18,000	T15	4,500
M5	19,750	T20	5,000
M5	21,750	T20	5,001
M5	23,400	T20	5,003
M6	27,000	T25	6,000
M6	28,500	T25	6,001
M6	32,500	T25	6,002



Drehmomentschlüssel

Artikel-Nr. 86844



Antrieb		Drehmoment Nm	L mm	Typ	Code-Nr.
1/4"	6-kant	0,8-2	160,000	A	2,000
1/4"	6-kant	2-8	200,000	A	8,000
1/4"	mit Quergriff	5-14	200,000	E	14,000



Torx-Einsätze

Artikel-Nr. 86845



Antrieb		Torx	L mm	Code-Nr.
1/4	6-kant	T7	25,000	7,000
1/4	6-kant	T8	25,000	8,000
1/4	6-kant	T9	25,000	9,000
1/4	6-kant	T10	25,000	10,000
1/4	6-kant	T15	25,000	15,000
1/4	6-kant	T20	25,000	20,000
1/4	6-kant	T25	25,000	25,001



Torx-Schraubendreher

Artikel-Nr. 86842



Torx-Schraubendreher

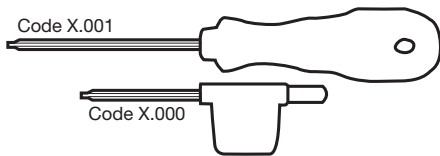

Torx	Code-Nr.
T6	6,000
T6	6,001
T7	7,000
T7	7,001
T8	8,001
T9	9,001
T10	10,001
T15	15,000
T20	20,001
T25	25,001

TECHNISCHER TEIL



DIE BESCHICHTUNGEN



○ **Blanke Oberfläche**

- ▼ Speziell für die Bearbeitung von Aluminiumguss- als auch Aluminiumknetlegierungen mit moderatem Siliziumgehalt, liefern unbeschichtete Wechselplatten sehr gute Zerspanungsleistungen. Um dem hier dominanten Adhäsionsverschleiß (Aufbauschneidenbildung) zu begegnen, sind diese Wechselplatten durch eine spezielle Geometrie, in Verbindung mit hohen Oberflächengüten im Bereich der Ausspitzung, Nut und Freiflächen, bestens an dieses Einsatzfeld angepasst.



● **FIRE-/nanoFIRE-Schicht**

- ▼ Optisches Kennzeichen: Farbe Schwarzviolett
- ▼ Multilayer-TiAlN-Schicht mit gradientem Aufbau. Allroundschicht mit min. 2 mal höherer Leistung als TiN. Vereint die Vorteile von TiN, TiAlN und TiCN. Exzellente, sozusagen „feuerfeste“ Wärmeisolierung. Hohe Zähigkeit.



● **AlTiNnano-Schicht**

- ▼ Optisches Kennzeichen: Farbe Schwarzviolett
- ▼ Die bewährte Beschichtung auf TiAlN-Basis aus unserem Hause wurde kontinuierlich weiterentwickelt. Die optimierten strukturellen, chemischen und mechanischen Eigenschaften der AlTiN-Schicht führen zu einer extrem hohen Warmhärte, einer sehr guten Oxidationsbeständigkeit sowie einer exzellenten Schichthftung. Diese Schicht eignet sich nur in Verbindung mit Hartmetall für die Bearbeitung schwer zerspanbarer Materialien wie zum Beispiel Inconel und gehärteten Stählen sowie für die Hartzerspannung (> 52 HRC) und die HSC-Bearbeitung. Außerdem sehr gut geeignet für die Bearbeitung von rostfreien Stählen.



Y TiAlSiN-Schicht

- ▼ Optisches Kennzeichen: Farbe Bronzerot
- ▼ Hochharte, warmfeste Mehrlagenschicht speziell für die Bearbeitung hochfester sowie gehärteter Stähle und von Gusseisen. Dank ihrer Nanocomposite-Struktur mit einem Schichtaufbau aus TiAlN und SiN erreicht sie die extreme Härte von 5500 HV.



T TiN-Schicht

- ▼ Optisches Kennzeichen: Farbe Goldgelb
- ▼ Bewährte, kostengünstige Allroundschicht mit einer Härte von 2200 HV. Sehr gute Ergebnisse bei der allgemeinen Stahlbearbeitung.



A TiAlN-Schicht

- ▼ Optisches Kennzeichen: Farbe Schwarzviolett
- ▼ Spezialschicht für Zerspanungsaufgaben in abrasiven Werkstoffen (Guss, AlSi) und/oder hohen Temperaturbelastungen, also bei Einsätzen ohne Kühlung oder eingeschränkter Kühlmöglichkeit, wie bei tiefen Bohrungen oder kleinen Durchmessern. Speziell hier gilt, dass erst bei höheren Schnittdaten die Schicht zu deutlichen Leistungsverbesserungen führt.

MULTIPLEX HPC – TECHNIK UND VORTEILE

BEIM EINSATZ VON HARTNER MULTIPLEX HPC WERKZEUGEN BEACHTEN SIE BITTE FOLGENDE HINWEISE UND EMPFEHLUNGEN:

Wir empfehlen, bei jedem Plattenwechsel auch die Spannschraube zu wechseln!
Jeder Halter wird deshalb mit Spannschraube, Artikel-Nr. 86843, und
Schraubendreher, Artikel-Nr. 86842, ausgeliefert.

Jede Wechselplatte wird ebenfalls mit Spannschraube, Artikel-Nr. 86843, ausgeliefert.
Bitte beachten Sie beim Plattenwechsel die folgenden Anzugsmomente für die
Spannschraube. Ihre Einhaltung ist für optimale Bearbeitungsergebnisse unbedingt
erforderlich!

Durchmesserbereich	11,0 - 12,99	13,0 - 13,99	14,0 - 15,99	16,0 - 17,99	18,0 - 19,99	20,0 - 21,99	22,0 - 29,99	30,0 - 40,00
Gewinde	M2,2	M2,5	M3	M3,5	M4	M4,5	M5	M6
Torxgröße	T7	T8	T9	T10	T15	T15	T20	T25
Anzugsmoment [Nm]	0,8	1,0	1,7	2,7	4,0	6,0	8,0	14,0

Angaben sind gültig für Gewindesicherung (Loctite)!

- ▼ Bei Durchgangsbohrungen ist darauf zu achten, dass die Führungsfasen im Eingriff bleiben. Außerdem empfehlen wir, vor dem Durchbohren den Vorschub zu reduzieren.
- ▼ Multiplex HPC ist im Gegensatz zum klassischen Wendeplattenbohrer auch zum Bohren von Blechpaketen geeignet.
- ▼ Bei Drehmaschinen (stehendes Bohrwerkzeug) ist darauf zu achten, dass das Werkzeug exakt auf Mitte steht.
- ▼ Voraussetzung für eine optimale Zerspanung ist eine ausreichende Kühlschmierstoff-Versorgung durch Emulsion oder Öl.

PILOTIEREN / SENKEN

- ▼ Generell empfehlen wir bei Bohrtiefen ab $5 \times D$ mit Halter Art.-Nr. 86681 und Pilotierplatte Art.-Nr. 86721 zu zentrieren bzw. zu pilotieren. Alternativ können – abhängig vom zu bearbeitenden Werkstoff – TS-DRILLS vom Typ TS 100 U oder TS 100 INOX eingesetzt werden.
- ▼ Beim Bohren ohne Anzentrieren empfehlen wir eine Reduzierung des Vorschubs während des Anbohrens.

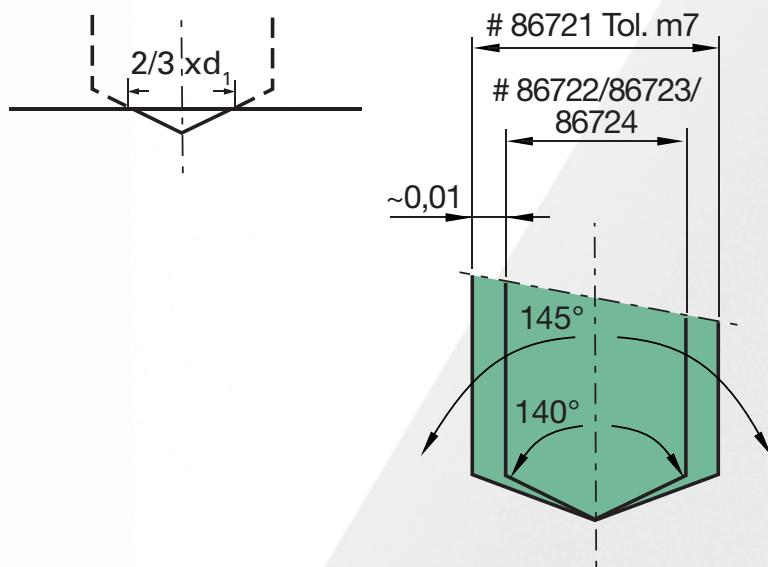

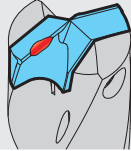
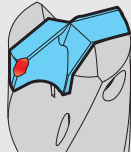
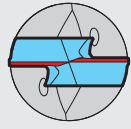
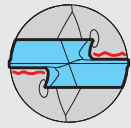
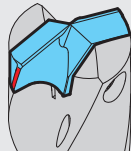
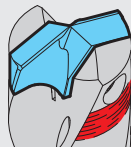

Finden und Beseitigen von Problemen

Fehler	Ursachen	Gegenmaßnahmen
1 Aufbauschneide 	<ul style="list-style-type: none"> ■ Schnittgeschwindigkeit zu klein ■ Hauptschneidenabzug zu groß ■ Blanke Hauptschneide 	<ul style="list-style-type: none"> ■ Schnittgeschwindigkeit erhöhen ■ Hauptschneidenabzug verkleinern ■ Werkzeug beschichten lassen
2 Eckenausbrüche 	<ul style="list-style-type: none"> ■ Instabile Verhältnisse, Werkzeugschwingung ungenügend ■ Rundlauffehler zu groß ■ Unterbrochener Schnitt 	<ul style="list-style-type: none"> ■ Werkstück stabiler spannen ■ Rundlauf kontrollieren, wenn möglich korrigieren ■ Vorschub zurücknehmen
3 Starker Freiflächenverschleiß 	<ul style="list-style-type: none"> ■ Schnittgeschwindigkeit zu groß ■ Vorschub zu klein ■ Freiwinkel zu klein 	<ul style="list-style-type: none"> ■ Schnittgeschwindigkeit zurücknehmen ■ Vorschub erhöhen ■ Freiwinkel erhöhen
4 Ausbrüche an der Hauptschneide 	<ul style="list-style-type: none"> ■ Instabile Verhältnisse, Werkstückspannung ungenügend ■ Unterbrochener Schnitt ■ Maximale Verschleißbreitenmarke überschritten ■ Falscher Werkzeugtyp 	<ul style="list-style-type: none"> ■ Werkstück stabiler spannen ■ Vorschub zurücknehmen ■ Werkzeugintervalle verkürzen ■ Geeignetes Werkzeug verwenden (siehe Auswahlhilfe)
5 Rundfasenverschleiß 	<ul style="list-style-type: none"> ■ Instabile Verhältnisse, Werkstückspannung ungenügend ■ Rundlauffehler zu groß ■ Verjüngung zu klein ■ Falscher Kühlschmierstoff (Öl), zu magere Emulsion 	<ul style="list-style-type: none"> ■ Werkstück stabiler spannen ■ Rundlauf kontrollieren, wenn möglich korrigieren ■ Verjüngung erhöhen ■ Emulsion fetter machen oder Öl verwenden
6 Riefen am Halterrücken 	<ul style="list-style-type: none"> ■ Instabile Verhältnisse, Werkstückspannung ungenügend ■ Rundlauffehler zu groß ■ Unterbrochener Schnitt ■ Abrasiver Werkstoff 	<ul style="list-style-type: none"> ■ Werkstück stabiler spannen ■ Rundlauf kontrollieren, wenn möglich korrigieren ■ Vorschub zurücknehmen ■ Emulsion fetter machen oder Öl verwenden

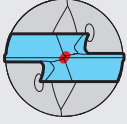
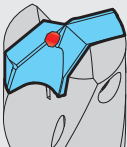
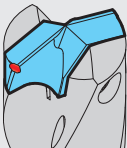
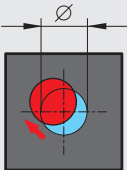
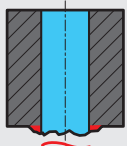
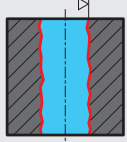

Finden und Beseitigen von Problemen

Fehler	Ursachen	Gegenmaßnahmen
7 Starker Querschneidenverschleiß 	<ul style="list-style-type: none"> ■ Schnittgeschwindigkeit zu klein ■ Vorschub zu groß ■ Hauptschneidenabzug zu groß 	<ul style="list-style-type: none"> ■ Schnittgeschwindigkeit erhöhen ■ Vorschub zurücknehmen ■ Hauptschneidenabzug verkleinern
8 Ausbrüche an Übergang, Ausspitzung und Hauptschneide 	<ul style="list-style-type: none"> ■ Freiwinkel zu klein ■ Hauptschneidenabzug zu groß ■ Falscher Werkzeugtyp 	<ul style="list-style-type: none"> ■ Freiwinkel erhöhen ■ Hauptschneidenabzug verkleinern ■ Geeignetes Werkzeug verwenden (siehe Auswahlhilfe)
9 Plastische Schneideckenverformung 	<ul style="list-style-type: none"> ■ Schnittgeschwindigkeit zu groß ■ Kühlmittelmenge nicht ausreichend ■ Falscher oder kein Eckenabzug 	<ul style="list-style-type: none"> ■ Schnittgeschwindigkeit zurücknehmen ■ Kühlmittelmenge (Volumen, Druck) erhöhen ■ Eckenabzug korrigieren
10 Mittenversatz 	<ul style="list-style-type: none"> ■ Instabile Verhältnisse, Werkstückspannung ungenügend ■ Rundlauffehler zu groß ■ Anbohren in schräger Fläche ■ Restquerschneide zu groß 	<ul style="list-style-type: none"> ■ Werkstück stabiler spannen ■ Rundlauf kontrollieren, wenn möglich korrigieren ■ Bohrgrund mit Fräser (2-schneidig) anbringen ■ Restquerschneide verkleinern
11 Starker Grat am Bohrungsausgang 	<ul style="list-style-type: none"> ■ Vorschub zu groß ■ Max. Verschleißbreitenmarke überschritten ■ Hauptschneidenabzug zu groß 	<ul style="list-style-type: none"> ■ Vorschub zurücknehmen ■ Werkzeugwechselintervalle verkürzen ■ Hauptschneidenabzug verkleinern
12 Schlechte Oberfläche 	<ul style="list-style-type: none"> ■ Instabile Verhältnisse, Werkstückspannung ungenügend ■ Rundlauffehler zu groß ■ Kühlmittelmenge nicht ausreichend 	<ul style="list-style-type: none"> ■ Werkstück stabiler spannen ■ Rundlauf kontrollieren, wenn möglich korrigieren ■ Kühlmittelmenge (Volumen, Druck) erhöhen



Einsatzempfehlungen Multiplex HPC

Artikel-Nr.
Norm/DIN
Schneidstoff
kombiniert mit Halter
Bohrtiefe
Oberfläche
Anwendung
Programm Seite

Bohrer-Ø mm	Vorschubreihen-Code								
	1	2	3	4	5	6	7	8	9
	f (mm/U)								
10,00	0,080	0,100	0,125	0,160	0,200	0,250	0,315	0,400	0,400
12,50	0,080	0,100	0,125	0,160	0,200	0,250	0,315	0,400	0,500
16,00	0,100	0,125	0,160	0,200	0,250	0,315	0,400	0,500	0,630
20,00	0,125	0,160	0,200	0,250	0,315	0,400	0,500	0,630	0,630
25,00	0,160	0,200	0,250	0,315	0,400	0,500	0,630	0,800	0,800
31,50	0,160	0,200	0,250	0,315	0,400	0,500	0,630	0,800	1,000
40,00	0,200	0,250	0,315	0,400	0,500	0,630	0,800	1,000	1,250

Werkstoffbezogene Kühlmittel:

- Luft
- Öl
- Emulsion

Alle Angaben sind Richtwerte. Die tatsächlich erreichbaren Schnittgeschwindigkeiten und Vorschübe hängen von den jeweiligen Bearbeitungsbedingungen ab.
Wir empfehlen entsprechende Bohrversuche.

Werkstoffgruppe	Werkstoffbeispiele, neue Bezeichnung (in Klammern alte Bezeichnung) Fettgedruckte Zahlen = Werkstoff-Nr. nach DIN EN	Zugfestigkeit MPa (N/mm ²)	Härte	Kühl- mittel
Allgemeine Baustähle	1.0035 S185(St33), 1.0486 P275N(StE285), 1.0345 P235GH(H1), 1.0425 P265GH(H2) 1.0050 E295 (St50-2), 1.0070 E360 (St70-2), 1.8937 P500NH (WStE500)	≤500 ≤1000		○ ○
Automatenstähle	1.0718 11SMnPb30 (9SMnPb28), 1.0736 11SMn37 (9SMn36) 1.0727 46S20 (45S20), 1.0728 (60S20), 1.0757 46SPb20 (45SPb20)	≤850 ≤1000		○ ○
Unlegierte Vergütungsstähle	1.0402 C22, 1.1178 C30E (Ck30) 1.0503 C45, 1.1191 C45E (Ck45) 1.0601 C60, 1.1221 C60E (Ck60)	≤700 ≤850 ≤1000		○ ○ ○
Legierte Vergütungsstähle	1.5131 50MnSi4, 1.7003 38Cr2, 1.7030 28Cr4 1.5710 36NiCr6, 1.7035 41Cr4, 1.7225 42CrMo4	≤1000 ≤1400		○ ○
Unlegierte Einsatzstähle	1.0301 (C10), 1.1121 C10E (Ck10)	≤850		○
Legierte Einsatzstähle	1.7276 10CrMo11, 1.5125 11MnSi6 1.5752 15NiCr13, 1.7131 16MnCr5, 1.7264 20CrMo5	≤1000 ≤1400		● ●
Nitrierstähle	1.8504 34CrAl6 1.8519 31CrMoV9, 1.8550 34CrAlNi7	≤1000 ≤1400		○ ●
Werkzeugstähle	1.1750 C75W, 1.2067 102Cr6, 1.2307 29CrMoV9 1.2080 X210Cr12, 1.2083 X42Cr13, 1.2419 105WCr6, 1.2767 X45NiCrMo4	≤850 ≤1400		○ ●
Schnellarbeitsstähle	1.3243 S 6-5-2-5, 1.3343 S 6-5-2, 1.3344 S 6-5-3	≤1400		●
Federstähle	1.5026 55Si7, 1.7176 55Cr3, 1.8159 51CrV4 (51CrV4)		≤350 HB	●
Gehärtete Stähle	-		≤48 HRC ≤66 HRC	● ●
Rostfreie Stähle, geschwefelt austenitisch martensitisch	1.4005 X12CrS13, 1.4104 X14CrMoS17, 1.86681 X6CrMoS17, 1.4305 X8CrNiS18-9 1.4301 X5CrNi18-10 (V2A), 1.4541 X6CrNiTi18-10, 1.4571 X6CrNiMoTi 17-12-2 (V4A) 1.4057 X20CrNi172 (X17CrNi16-2), 1.4122 X39CrMo17-1, 1.4521 X2CrMoTi18-2	≤900 ≤1100 ≤1500		● ● ●
Gusseisen	0.6010 EN-GJL-100 (GG10), 0.6020 EN-GJL-200 (GG20) 0.6025 EN-GJL-250 (GG25), 0.6035 EN-GJL-350 (GG35)		≤240 HB ≤350 HB	○ ○
Kugelgraphit- und Temperguss	0.7050 EN-GJS-500-7 (GGG50), 0.8035 EN-GJMW-350-4 (GTW35) 0.7070 EN-GJS-700-2 (GGG70), 0.8170 EN-GJMB-700-2 (GTS70)		≤240 HB ≤350 HB	○ ○
Hartguss	-		≤350 HB	○
Neue Gusswerkstoffe GGV	EN-GJV250 (GGV25), EN-GJV350 (GGV35) EN-GJV400 (GGV40), EN-GJV500 (GGV50), SiMo 6		≤220 HB ≤300 HB	○ ○
Neue Gusswerkstoffe ADI	EN-GJS-800-8 (ADI800), EN-GJS-1000-5 (ADI1000) EN-GJS-1200-2 (ADI1200), EN-GJS-1400-1 (ADI1400)	≤1000 ≤1400		○ ○
Sonderlegierungen	Nimonic, Inconel, Monel, Hastelloy	≤2000		●
Titan und Titan-Legierungen	3.7024 Ti99,5, 3.7114 TiAl5Sn2,5, 3.7124 TiCu2 3.7154 TiAl6Zr5, 3.7165 TiAl6V4, 3.7184 TiAl4Mo4Sn2,5, - TiAl8Mo1V1	≤850 ≤1400		● ●
Aluminium und Al-Legierungen	3.0255 Al99,5, 3.2315 AlMgSi1, 3.3515 AlMg1	≤400		○
Al-Knetlegierungen	3.0615 AlMgSiPb, 3.1325 AlCuMg1, 3.3245 AlMg3Si, 3.4365 AlZnMgCu1,5	≤650		○
Al-Gusslegierungen ≤ 10 % Si ≤ 24 % Si	3.2131 G-AlSi5Cu1, 3.2153 G-AlSi7Cu3, 3.2573 G-AlSi9 3.2581 G-AlSi12, 3.2583 G-AlSi12Cu, - G-AlSi12CuNiMg	≤600 ≤600		○ ○
Magnesium-Legierungen	3.5200 MgMn2, 3.5812.05 G-MgAl8Zn1, 3.5612.05 G-MgAl6Zn1	≤400		○
Kupfer, niedriglegiert	2.0070 SE-Cu, 2.1020 CuSn6, 2.1096 G-CuSn5ZnPb	≤500		○
Messing, kurzspanend langspanend	2.0380 CuZn39Pb2, 2.0401 CuZn39Pb3, 2.0410 CuZn43Pb2 2.0250 CuZn20, 2.0280 CuZn33, 2.0332 CuZn37Pb0,5	≤600 ≤600		○ ○
Bronzen, kurzspanend	2.1090 CuSn7ZnPb, 2.1170 CuPb5Sn5, 2.1176 CuPb10Sn 2.0790 CuNi18Zn19Pb	≤600 ≤850		○ ○
Bronzen, langspanend	2.0916 CuAl5, 2.0960 CuAl9Mn, 2.1050 CuSn10 2.0980 CuAl11Ni, 2.1247 CuBe2	≤850 ≤1000		○ ○
Kunststoffe, duroplastisch thermoplastisch	Bakelit, Resopal, Pertinax, Moltopren Plexiglas, Hostalen, Novodur, Makralon	≤150 ≤100		○ ○
aramidfaserverstärkt	Kevlar	≤1000		○
glas-/kohlefaserverstärkt	GFK/CFK	≤1000		○



Einsatzempfehlungen Multiplex HPC

Artikel-Nr.
Norm/DIN
Schneidstoff
kombiniert mit Halter
Bohrtiefe
Oberfläche
Anwendung
Programm Seite

Bohrer-Ø mm	Vorschubreihen-Code								
	1	2	3	4	5	6	7	8	9
	f (mm/U)								
10,00	0,080	0,100	0,125	0,160	0,200	0,250	0,315	0,400	0,400
12,50	0,080	0,100	0,125	0,160	0,200	0,250	0,315	0,400	0,500
16,00	0,100	0,125	0,160	0,200	0,250	0,315	0,400	0,500	0,630
20,00	0,125	0,160	0,200	0,250	0,315	0,400	0,500	0,630	0,630
25,00	0,160	0,200	0,250	0,315	0,400	0,500	0,630	0,800	0,800
31,50	0,160	0,200	0,250	0,315	0,400	0,500	0,630	0,800	1,000
40,00	0,200	0,250	0,315	0,400	0,500	0,630	0,800	1,000	1,250

Werkstoffbezogene Kühlmittel:

- Luft
- Öl
- Emulsion

Alle Angaben sind Richtwerte. Die tatsächlich erreichbaren Schnittgeschwindigkeiten und Vorschübe hängen von den jeweiligen Bearbeitungsbedingungen ab.
Wir empfehlen entsprechende Bohrversuche.

Werkstoffgruppe	Werkstoffbeispiele, neue Bezeichnung (in Klammern alte Bezeichnung) Fettgedruckte Zahlen = Werkstoff-Nr. nach DIN EN	Zugfestigkeit MPa (N/mm ²)	Härte	Kühl- mittel
Allgemeine Baustähle	1.0035 S185(St33), 1.0486 P275N(StE285), 1.0345 P235GH(H1), 1.0425 P265GH(H2) 1.0050 E295 (St50-2), 1.0070 E360 (St70-2), 1.8937 P500NH (WStE500)	≤500 ≤1000		○ ○
Automatenstähle	1.0718 11SMnPb30 (9SMnPb28), 1.0736 11SMn37 (9SMn36) 1.0727 46S20 (45S20), 1.0728 (60S20), 1.0757 46SPb20 (45SPb20)	≤850 ≤1000		○ ○
Unlegierte Vergütungsstähle	1.0402 C22, 1.1178 C30E (Ck30) 1.0503 C45, 1.1191 C45E (Ck45) 1.0601 C60, 1.1221 C60E (Ck60)	≤700 ≤850 ≤1000		○ ○ ○
Legierte Vergütungsstähle	1.5131 50MnSi4, 1.7003 38Cr2, 1.7030 28Cr4 1.5710 36NiCr6, 1.7035 41Cr4, 1.7225 42CrMo4	≤1000 ≤1400		○ ○
Unlegierte Einsatzstähle	1.0301 (C10), 1.1121 C10E (Ck10)	≤850		○
Legierte Einsatzstähle	1.7276 10CrMo11, 1.5125 11MnSi6 1.5752 15NiCr13, 1.7131 16MnCr5, 1.7264 20CrMo5	≤1000 ≤1400		● ●
Nitrierstähle	1.8504 34CrAl6 1.8519 31CrMoV9, 1.8550 34CrAlNi7	≤1000 ≤1400		○ ●
Werkzeugstähle	1.1750 C75W, 1.2067 102Cr6, 1.2307 29CrMoV9 1.2080 X210Cr12, 1.2083 X42Cr13, 1.2419 105WCr6, 1.2767 X45NiCrMo4	≤850 ≤1400		○ ●
Schnellarbeitsstähle	1.3243 S 6-5-2-5, 1.3343 S 6-5-2, 1.3344 S 6-5-3	≤1400		●
Federstähle	1.5026 55Si7, 1.7176 55Cr3, 1.8159 51CrV4 (51CrV4)		≤350 HB	●
Gehärtete Stähle	-		≤48 HRC ≤66 HRC	● ●
Rostfreie Stähle, geschwefelt austenitisch martensitisch	1.4005 X12CrS13, 1.4104 X14CrMoS17, 1.86681 X6CrMoS17, 1.4305 X8CrNiS18-9 1.4301 X5CrNi18-10 (V2A), 1.4541 X6CrNiTi18-10, 1.4571 X6CrNiMoTi 17-12-2 (V4A) 1.4057 X20CrNi172 (X17CrNi16-2), 1.4122 X39CrMo17-1, 1.4521 X2CrMoTi18-2	≤900 ≤1100 ≤1500		● ● ●
Gusseisen	0.6010 EN-GJL-100 (GG10), 0.6020 EN-GJL-200 (GG20) 0.6025 EN-GJL-250 (GG25), 0.6035 EN-GJL-350 (GG35)		≤240 HB ≤350 HB	○ ○
Kugelgraphit- und Temperguss	0.7050 EN-GJS-500-7 (GGG50), 0.8035 EN-GJMW-350-4 (GTW35) 0.7070 EN-GJS-700-2 (GGG70), 0.8170 EN-GJMB-700-2 (GTS70)		≤240 HB ≤350 HB	○ ○
Hartguss	-		≤350 HB	○
Neue Gusswerkstoffe GGV	EN-GJV250 (GGV25), EN-GJV350 (GGV35) EN-GJV400 (GGV40), EN-GJV500 (GGV50), SiMo 6		≤220 HB ≤300 HB	○ ○
Neue Gusswerkstoffe ADI	EN-GJS-800-8 (ADI800), EN-GJS-1000-5 (ADI1000) EN-GJS-1200-2 (ADI1200), EN-GJS-1400-1 (ADI1400)	≤1000 ≤1400		○ ○
Sonderlegierungen	Nimonic, Inconel, Monel, Hastelloy	≤2000		●
Titan und Titan-Legierungen	3.7024 Ti99,5, 3.7114 TiAl5Sn2,5, 3.7124 TiCu2 3.7154 TiAl6Zr5, 3.7165 TiAl6V4, 3.7184 TiAl4Mo4Sn2,5, - TiAl8Mo1V1	≤850 ≤1400		● ●
Aluminium und Al-Legierungen	3.0255 Al99,5, 3.2315 AlMgSi1, 3.3515 AlMg1	≤400		○
Al-Knetlegierungen	3.0615 AlMgSiPb, 3.1325 AlCuMg1, 3.3245 AlMg3Si, 3.4365 AlZnMgCu1,5	≤650		○
Al-Gusslegierungen ≤ 10 % Si ≤ 24 % Si	3.2131 G-AlSi5Cu1, 3.2153 G-AlSi7Cu3, 3.2573 G-AlSi9 3.2581 G-AlSi12, 3.2583 G-AlSi12Cu, - G-AlSi12CuNiMg	≤600 ≤600		○ ○
Magnesium-Legierungen	3.5200 MgMn2, 3.5812.05 G-MgAl8Zn1, 3.5612.05 G-MgAl6Zn1	≤400		○
Kupfer, niedriglegiert	2.0070 SE-Cu, 2.1020 CuSn6, 2.1096 G-CuSn5ZnPb	≤500		○
Messing, kurzspanend langspanend	2.0380 CuZn39Pb2, 2.0401 CuZn39Pb3, 2.0410 CuZn43Pb2 2.0250 CuZn20, 2.0280 CuZn33, 2.0332 CuZn37Pb0,5	≤600 ≤600		○ ○
Bronzen, kurzspanend	2.1090 CuSn7ZnPb, 2.1170 CuPb5Sn5, 2.1176 CuPb10Sn 2.0790 CuNi18Zn19Pb	≤600 ≤850		○ ○
Bronzen, langspanend	2.0916 CuAl5, 2.0960 CuAl9Mn, 2.1050 CuSn10 2.0980 CuAl11Ni, 2.1247 CuBe2	≤850 ≤1000		○ ○
Kunststoffe, duroplastisch thermoplastisch	Bakelit, Resopal, Pertinax, Moltopren Plexiglas, Hostalen, Novodur, Makralon	≤150 ≤100		○ ○
aramidfaserverstärkt	Kevlar	≤1000		○
glas-/kohlefaserverstärkt	GFK/CFK	≤1000		○



HARTNER

≤3xD

86722
WN
VHM
86683
3xD
F
Stahl
20

86725
WN
VHM
86683
3xD
a
rostfreie Stähle
24

86723
WN
VHM
86683
3xD
Y
Guss
28

86724
WN
VHM
86683
3xD
○
Al/Al-Legierung
32

86729
WN
VHM
86683
3xD
F
für Stahlträger
40

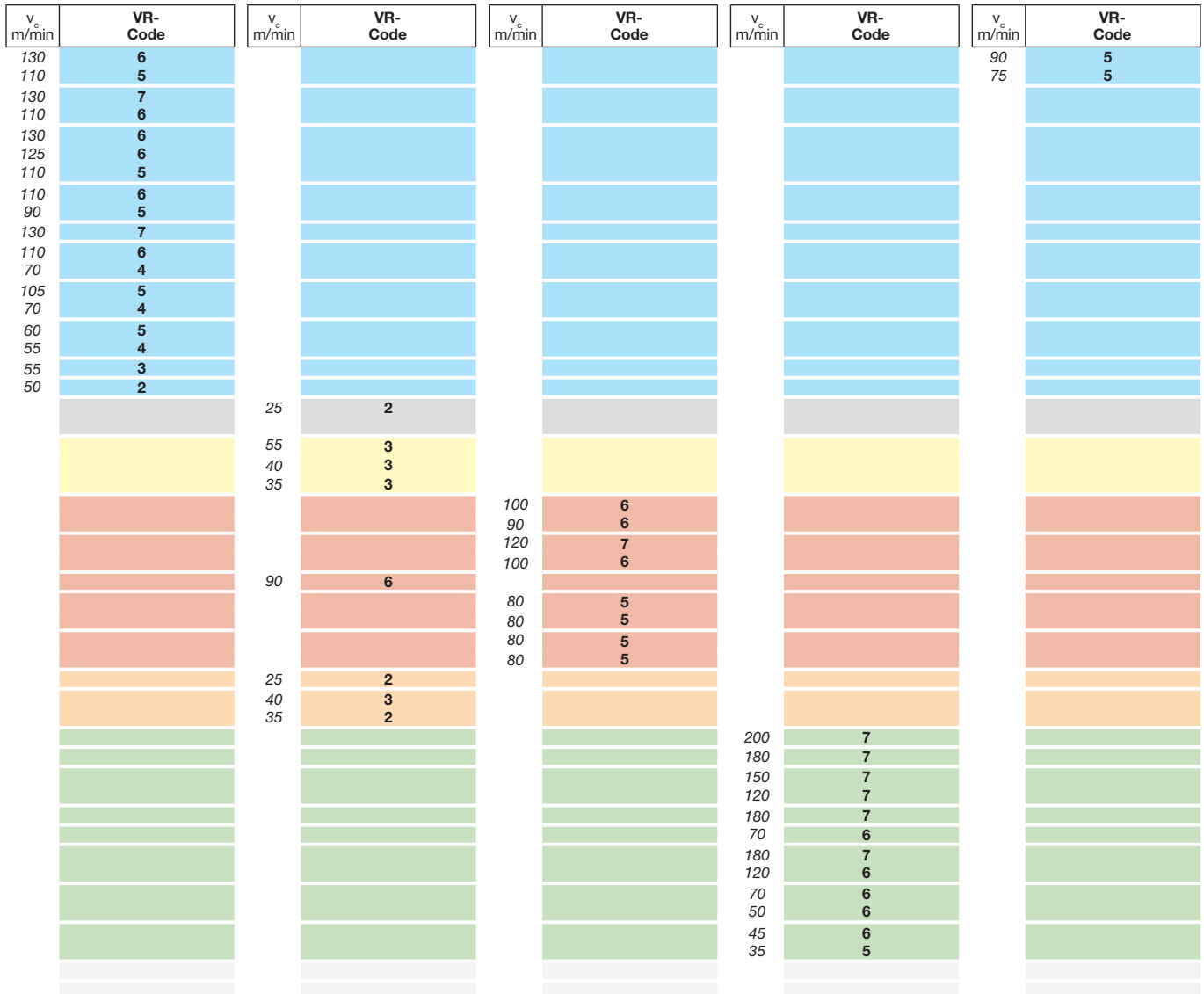



Einsatzempfehlungen Multiplex HPC

Artikel-Nr.
Norm/DIN
Schneidstoff
kombiniert mit Halter
Bohrtiefe
Oberfläche
Anwendung
Programm Seite

Bohrer-Ø mm	Vorschubreihen-Code								
	1	2	3	4	5	6	7	8	9
	f (mm/U)								
10,00	0,080	0,100	0,125	0,160	0,200	0,250	0,315	0,400	0,400
12,50	0,080	0,100	0,125	0,160	0,200	0,250	0,315	0,400	0,500
16,00	0,100	0,125	0,160	0,200	0,250	0,315	0,400	0,500	0,630
20,00	0,125	0,160	0,200	0,250	0,315	0,400	0,500	0,630	0,630
25,00	0,160	0,200	0,250	0,315	0,400	0,500	0,630	0,800	0,800
31,50	0,160	0,200	0,250	0,315	0,400	0,500	0,630	0,800	1,000
40,00	0,200	0,250	0,315	0,400	0,500	0,630	0,800	1,000	1,250

Werkstoffbezogene Kühlmittel:

- Luft
- Öl
- Emulsion

Alle Angaben sind Richtwerte. Die tatsächlich erreichbaren Schnittgeschwindigkeiten und Vorschübe hängen von den jeweiligen Bearbeitungsbedingungen ab.
Wir empfehlen entsprechende Bohrversuche.

Werkstoffgruppe	Werkstoffbeispiele, neue Bezeichnung (in Klammern alte Bezeichnung) Fettgedruckte Zahlen = Werkstoff-Nr. nach DIN EN	Zugfestigkeit MPa (N/mm ²)	Härte	Kühl- mittel
Allgemeine Baustähle	1.0035 S185(St33), 1.0486 P275N(StE285), 1.0345 P235GH(H1), 1.0425 P265GH(H2) 1.0050 E295 (St50-2), 1.0070 E360 (St70-2), 1.8937 P500NH (WStE500)	≤500 ≤1000		○ ○
Automatenstähle	1.0718 11SMnPb30 (9SMnPb28), 1.0736 11SMn37 (9SMn36) 1.0727 46S20 (45S20), 1.0728 (60S20), 1.0757 46SPb20 (45SPb20)	≤850 ≤1000		○ ○
Unlegierte Vergütungsstähle	1.0402 C22, 1.1178 C30E (Ck30) 1.0503 C45, 1.1191 C45E (Ck45) 1.0601 C60, 1.1221 C60E (Ck60)	≤700 ≤850 ≤1000		○ ○ ○
Legierte Vergütungsstähle	1.5131 50MnSi4, 1.7003 38Cr2, 1.7030 28Cr4 1.5710 36NiCr6, 1.7035 41Cr4, 1.7225 42CrMo4	≤1000 ≤1400		○ ○
Unlegierte Einsatzstähle	1.0301 (C10), 1.1121 C10E (Ck10)	≤850		○
Legierte Einsatzstähle	1.7276 10CrMo11, 1.5125 11MnSi6 1.5752 15NiCr13, 1.7131 16MnCr5, 1.7264 20CrMo5	≤1000 ≤1400		● ●
Nitrierstähle	1.8504 34CrAl6 1.8519 31CrMoV9, 1.8550 34CrAlNi7	≤1000 ≤1400		○ ●
Werkzeugstähle	1.1750 C75W, 1.2067 102Cr6, 1.2307 29CrMoV9 1.2080 X210Cr12, 1.2083 X42Cr13, 1.2419 105WCr6, 1.2767 X45NiCrMo4	≤850 ≤1400		○ ●
Schnellarbeitsstähle	1.3243 S 6-5-2-5, 1.3343 S 6-5-2, 1.3344 S 6-5-3	≤1400		●
Federstähle	1.5026 55Si7, 1.7176 55Cr3, 1.8159 51CrV4 (51CrV4)		≤350 HB	●
Gehärtete Stähle	-		≤48 HRC ≤66 HRC	● ●
Rostfreie Stähle, geschwefelt austenitisch martensitisch	1.4005 X12CrS13, 1.4104 X14CrMoS17, 1.86681 X6CrMoS17, 1.4305 X8CrNiS18-9 1.4301 X5CrNi18-10 (V2A), 1.4541 X6CrNiTi18-10, 1.4571 X6CrNiMoTi 17-12-2 (V4A) 1.4057 X20CrNi172 (X17CrNi16-2), 1.4122 X39CrMo17-1, 1.4521 X2CrMoTi18-2	≤900 ≤1100 ≤1500		● ● ●
Gusseisen	0.6010 EN-GJL-100 (GG10), 0.6020 EN-GJL-200 (GG20) 0.6025 EN-GJL-250 (GG25), 0.6035 EN-GJL-350 (GG35)		≤240 HB ≤350 HB	○ ○
Kugelgraphit- und Temperguss	0.7050 EN-GJS-500-7 (GGG50), 0.8035 EN-GJMW-350-4 (GTW35) 0.7070 EN-GJS-700-2 (GGG70), 0.8170 EN-GJMB-700-2 (GTS70)		≤240 HB ≤350 HB	○ ○
Hartguss	-		≤350 HB	○
Neue Gusswerkstoffe GGV	EN-GJV250 (GGV25), EN-GJV350 (GGV35) EN-GJV400 (GGV40), EN-GJV500 (GGV50), SiMo 6		≤220 HB ≤300 HB	○ ○
Neue Gusswerkstoffe ADI	EN-GJS-800-8 (ADI800), EN-GJS-1000-5 (ADI1000) EN-GJS-1200-2 (ADI1200), EN-GJS-1400-1 (ADI1400)	≤1000 ≤1400		○ ○
Sonderlegierungen	Nimonic, Inconel, Monel, Hastelloy	≤2000		●
Titan und Titan-Legierungen	3.7024 Ti99,5, 3.7114 TiAl5Sn2,5, 3.7124 TiCu2 3.7154 TiAl6Zr5, 3.7165 TiAl6V4, 3.7184 TiAl4Mo4Sn2,5, - TiAl8Mo1V1	≤850 ≤1400		● ●
Aluminium und Al-Legierungen	3.0255 Al99,5, 3.2315 AlMgSi1, 3.3515 AlMg1	≤400		○
Al-Knetlegierungen	3.0615 AlMgSiPb, 3.1325 AlCuMg1, 3.3245 AlMg3Si, 3.4365 AlZnMgCu1,5	≤650		○
Al-Gusslegierungen ≤ 10 % Si ≤ 24 % Si	3.2131 G-AlSi5Cu1, 3.2153 G-AlSi7Cu3, 3.2573 G-AlSi9 3.2581 G-AlSi12, 3.2583 G-AlSi12Cu, - G-AlSi12CuNiMg	≤600 ≤600		○ ○
Magnesium-Legierungen	3.5200 MgMn2, 3.5812.05 G-MgAl8Zn1, 3.5612.05 G-MgAl6Zn1	≤400		○
Kupfer, niedriglegiert	2.0070 SE-Cu, 2.1020 CuSn6, 2.1096 G-CuSn5ZnPb	≤500		○
Messing, kurzspanend langspanend	2.0380 CuZn39Pb2, 2.0401 CuZn39Pb3, 2.0410 CuZn43Pb2 2.0250 CuZn20, 2.0280 CuZn33, 2.0332 CuZn37Pb0,5	≤600 ≤600		○ ○
Bronzen, kurzspanend	2.1090 CuSn7ZnPb, 2.1170 CuPb5Sn5, 2.1176 CuPb10Sn 2.0790 CuNi18Zn19Pb	≤600 ≤850		○ ○
Bronzen, langspanend	2.0916 CuAl5, 2.0960 CuAl9Mn, 2.1050 CuSn10 2.0980 CuAl11Ni, 2.1247 CuBe2	≤850 ≤1000		○ ○
Kunststoffe, duroplastisch thermoplastisch	Bakelit, Resopal, Pertinax, Moltopren Plexiglas, Hostalen, Novodur, Makralon	≤150 ≤100		○ ○
aramidfaserverstärkt	Kevlar	≤1000		○
glas-/kohlefaserverstärkt	GFK/CFK	≤1000		○



Einsatzempfehlungen Multiplex HPC

Artikel-Nr.
Norm/DIN
Schneidstoff
kombiniert mit Halter
Bohrtiefe
Oberfläche
Anwendung
Programm Seite

Bohrer-Ø mm	Vorschubreihen-Code								
	1	2	3	4	5	6	7	8	9
	f (mm/U)								
10,00	0,080	0,100	0,125	0,160	0,200	0,250	0,315	0,400	0,400
12,50	0,080	0,100	0,125	0,160	0,200	0,250	0,315	0,400	0,500
16,00	0,100	0,125	0,160	0,200	0,250	0,315	0,400	0,500	0,630
20,00	0,125	0,160	0,200	0,250	0,315	0,400	0,500	0,630	0,630
25,00	0,160	0,200	0,250	0,315	0,400	0,500	0,630	0,800	0,800
31,50	0,160	0,200	0,250	0,315	0,400	0,500	0,630	0,800	1,000
40,00	0,200	0,250	0,315	0,400	0,500	0,630	0,800	1,000	1,250

Werkstoffbezogene Kühlmittel:

- Luft
- Öl
- Emulsion

Alle Angaben sind Richtwerte. Die tatsächlich erreichbaren Schnittgeschwindigkeiten und Vorschübe hängen von den jeweiligen Bearbeitungsbedingungen ab.
Wir empfehlen entsprechende Bohrversuche.

Werkstoffgruppe	Werkstoffbeispiele, neue Bezeichnung (in Klammern alte Bezeichnung) Fettgedruckte Zahlen = Werkstoff-Nr. nach DIN EN	Zugfestigkeit MPa (N/mm ²)	Härte	Kühl- mittel
Allgemeine Baustähle	1.0035 S185(St33), 1.0486 P275N(StE285), 1.0345 P235GH(H1), 1.0425 P265GH(H2) 1.0050 E295 (St50-2), 1.0070 E360 (St70-2), 1.8937 P500NH (WStE500)	≤500 ≤1000		○ ○
Automatenstähle	1.0718 11SMnPb30 (9SMnPb28), 1.0736 11SMn37 (9SMn36) 1.0727 46S20 (45S20), 1.0728 (60S20), 1.0757 46SPb20 (45SPb20)	≤850 ≤1000		○ ○
Unlegierte Vergütungsstähle	1.0402 C22, 1.1178 C30E (Ck30) 1.0503 C45, 1.1191 C45E (Ck45) 1.0601 C60, 1.1221 C60E (Ck60)	≤700 ≤850 ≤1000		○ ○ ○
Legierte Vergütungsstähle	1.5131 50MnSi4, 1.7003 38Cr2, 1.7030 28Cr4 1.5710 36NiCr6, 1.7035 41Cr4, 1.7225 42CrMo4	≤1000 ≤1400		○ ○
Unlegierte Einsatzstähle	1.0301 (C10), 1.1121 C10E (Ck10)	≤850		○
Legierte Einsatzstähle	1.7276 10CrMo11, 1.5125 11MnSi6 1.5752 15NiCr13, 1.7131 16MnCr5, 1.7264 20CrMo5	≤1000 ≤1400		● ●
Nitrierstähle	1.8504 34CrAl6 1.8519 31CrMoV9, 1.8550 34CrAlNi7	≤1000 ≤1400		○ ●
Werkzeugstähle	1.1750 C75W, 1.2067 102Cr6, 1.2307 29CrMoV9 1.2080 X210Cr12, 1.2083 X42Cr13, 1.2419 105WCr6, 1.2767 X45NiCrMo4	≤850 ≤1400		○ ●
Schnellarbeitsstähle	1.3243 S 6-5-2-5, 1.3343 S 6-5-2, 1.3344 S 6-5-3	≤1400		●
Federstähle	1.5026 55Si7, 1.7176 55Cr3, 1.8159 51CrV4 (51CrV4)		≤350 HB	●
Gehärtete Stähle	-		≤48 HRC ≤66 HRC	● ●
Rostfreie Stähle, geschwefelt austenitisch martensitisch	1.4005 X12CrS13, 1.4104 X14CrMoS17, 1.86681 X6CrMoS17, 1.4305 X8CrNiS18-9 1.4301 X5CrNi18-10 (V2A), 1.4541 X6CrNiTi18-10, 1.4571 X6CrNiMoTi 17-12-2 (V4A) 1.4057 X20CrNi172 (X17CrNi16-2), 1.4122 X39CrMo17-1, 1.4521 X2CrMoTi18-2	≤900 ≤1100 ≤1500		● ● ●
Gusseisen	0.6010 EN-GJL-100 (GG10), 0.6020 EN-GJL-200 (GG20) 0.6025 EN-GJL-250 (GG25), 0.6035 EN-GJL-350 (GG35)		≤240 HB ≤350 HB	○ ○
Kugelgraphit- und Temperguss	0.7050 EN-GJS-500-7 (GGG50), 0.8035 EN-GJMW-350-4 (GTW35) 0.7070 EN-GJS-700-2 (GGG70), 0.8170 EN-GJMB-700-2 (GTS70)		≤240 HB ≤350 HB	○ ○
Hartguss	-		≤350 HB	○
Neue Gusswerkstoffe GGV	EN-GJV250 (GGV25), EN-GJV350 (GGV35) EN-GJV400 (GGV40), EN-GJV500 (GGV50), SiMo 6		≤220 HB ≤300 HB	○ ○
Neue Gusswerkstoffe ADI	EN-GJS-800-8 (ADI800), EN-GJS-1000-5 (ADI1000) EN-GJS-1200-2 (ADI1200), EN-GJS-1400-1 (ADI1400)	≤1000 ≤1400		○ ○
Sonderlegierungen	Nimonic, Inconel, Monel, Hastelloy	≤2000		●
Titan und Titan-Legierungen	3.7024 Ti99,5, 3.7114 TiAl5Sn2,5, 3.7124 TiCu2 3.7154 TiAl6Zr5, 3.7165 TiAl6V4, 3.7184 TiAl4Mo4Sn2,5, - TiAl8Mo1V1	≤850 ≤1400		● ●
Aluminium und Al-Legierungen	3.0255 Al99,5, 3.2315 AlMgSi1, 3.3515 AlMg1	≤400		○
Al-Knetlegierungen	3.0615 AlMgSiPb, 3.1325 AlCuMg1, 3.3245 AlMg3Si, 3.4365 AlZnMgCu1,5	≤650		○
Al-Gusslegierungen ≤ 10 % Si ≤ 24 % Si	3.2131 G-AlSi5Cu1, 3.2153 G-AlSi7Cu3, 3.2573 G-AlSi9 3.2581 G-AlSi12, 3.2583 G-AlSi12Cu, - G-AlSi12CuNiMg	≤600 ≤600		○ ○
Magnesium-Legierungen	3.5200 MgMn2, 3.5812.05 G-MgAl8Zn1, 3.5612.05 G-MgAl6Zn1	≤400		○
Kupfer, niedriglegiert	2.0070 SE-Cu, 2.1020 CuSn6, 2.1096 G-CuSn5ZnPb	≤500		○
Messing, kurzspanend langspanend	2.0380 CuZn39Pb2, 2.0401 CuZn39Pb3, 2.0410 CuZn43Pb2 2.0250 CuZn20, 2.0280 CuZn33, 2.0332 CuZn37Pb0,5	≤600 ≤600		○ ○
Bronzen, kurzspanend	2.1090 CuSn7ZnPb, 2.1170 CuPb5Sn5, 2.1176 CuPb10Sn 2.0790 CuNi18Zn19Pb	≤600 ≤850		○ ○
Bronzen, langspanend	2.0916 CuAl5, 2.0960 CuAl9Mn, 2.1050 CuSn10 2.0980 CuAl11Ni, 2.1247 CuBe2	≤850 ≤1000		○ ○
Kunststoffe, duroplastisch thermoplastisch	Bakelit, Resopal, Pertinax, Moltopren Plexiglas, Hostalen, Novodur, Makralon	≤150 ≤100		○ ○
aramidfaserverstärkt	Kevlar	≤1000		○
glas-/kohlefaserverstärkt	GFK/CFK	≤1000		○



Einsatzempfehlungen Multiplex HPC

Artikel-Nr.
Norm/DIN
Schneidstoff
kombiniert mit Halter
Bohrtiefe
Oberfläche
Anwendung
Programm Seite

Bohrer-Ø mm	Vorschubreihen-Code								
	1	2	3	4	5	6	7	8	9
	f (mm/U)								
10,00	0,080	0,100	0,125	0,160	0,200	0,250	0,315	0,400	0,400
12,50	0,080	0,100	0,125	0,160	0,200	0,250	0,315	0,400	0,500
16,00	0,100	0,125	0,160	0,200	0,250	0,315	0,400	0,500	0,630
20,00	0,125	0,160	0,200	0,250	0,315	0,400	0,500	0,630	0,630
25,00	0,160	0,200	0,250	0,315	0,400	0,500	0,630	0,800	0,800
31,50	0,160	0,200	0,250	0,315	0,400	0,500	0,630	0,800	1,000
40,00	0,200	0,250	0,315	0,400	0,500	0,630	0,800	1,000	1,250

Werkstoffbezogene Kühlmittel:

- Luft
- Öl
- Emulsion

Alle Angaben sind Richtwerte. Die tatsächlich erreichbaren Schnittgeschwindigkeiten und Vorschübe hängen von den jeweiligen Bearbeitungsbedingungen ab.
Wir empfehlen entsprechende Bohrversuche.

Werkstoffgruppe	Werkstoffbeispiele, neue Bezeichnung (in Klammern alte Bezeichnung) Fettgedruckte Zahlen = Werkstoff-Nr. nach DIN EN	Zugfestigkeit MPa (N/mm ²)	Härte	Kühl- mittel
Allgemeine Baustähle	1.0035 S185(St33), 1.0486 P275N(StE285), 1.0345 P235GH(H1), 1.0425 P265GH(H2) 1.0050 E295 (St50-2), 1.0070 E360 (St70-2), 1.8937 P500NH (WStE500)	≤500 ≤1000		○ ○
Automatenstähle	1.0718 11SMnPb30 (9SMnPb28), 1.0736 11SMn37 (9SMn36) 1.0727 46S20 (45S20), 1.0728 (60S20), 1.0757 46SPb20 (45SPb20)	≤850 ≤1000		○ ○
Unlegierte Vergütungsstähle	1.0402 C22, 1.1178 C30E (Ck30) 1.0503 C45, 1.1191 C45E (Ck45) 1.0601 C60, 1.1221 C60E (Ck60)	≤700 ≤850 ≤1000		○ ○ ○
Legierte Vergütungsstähle	1.5131 50MnSi4, 1.7003 38Cr2, 1.7030 28Cr4 1.5710 36NiCr6, 1.7035 41Cr4, 1.7225 42CrMo4	≤1000 ≤1400		○ ○
Unlegierte Einsatzstähle	1.0301 (C10), 1.1121 C10E (Ck10)	≤850		○
Legierte Einsatzstähle	1.7276 10CrMo11, 1.5125 11MnSi6 1.5752 15NiCr13, 1.7131 16MnCr5, 1.7264 20CrMo5	≤1000 ≤1400		● ●
Nitrierstähle	1.8504 34CrAl6 1.8519 31CrMoV9, 1.8550 34CrAlNi7	≤1000 ≤1400		○ ●
Werkzeugstähle	1.1750 C75W, 1.2067 102Cr6, 1.2307 29CrMoV9 1.2080 X210Cr12, 1.2083 X42Cr13, 1.2419 105WCr6, 1.2767 X45NiCrMo4	≤850 ≤1400		○ ●
Schnellarbeitsstähle	1.3243 S 6-5-2-5, 1.3343 S 6-5-2, 1.3344 S 6-5-3	≤1400		●
Federstähle	1.5026 55Si7, 1.7176 55Cr3, 1.8159 51CrV4 (51CrV4)		≤350 HB	●
Gehärtete Stähle	-		≤48 HRC ≤66 HRC	● ●
Rostfreie Stähle, geschwefelt austenitisch martensitisch	1.4005 X12CrS13, 1.4104 X14CrMoS17, 1.86681 X6CrMoS17, 1.4305 X8CrNiS18-9 1.4301 X5CrNi18-10 (V2A), 1.4541 X6CrNiTi18-10, 1.4571 X6CrNiMoTi 17-12-2 (V4A) 1.4057 X20CrNi172 (X17CrNi16-2), 1.4122 X39CrMo17-1, 1.4521 X2CrMoTi18-2	≤900 ≤1100 ≤1500		● ● ●
Gusseisen	0.6010 EN-GJL-100 (GG10), 0.6020 EN-GJL-200 (GG20) 0.6025 EN-GJL-250 (GG25), 0.6035 EN-GJL-350 (GG35)		≤240 HB ≤350 HB	○ ○
Kugelgraphit- und Temperguss	0.7050 EN-GJS-500-7 (GGG50), 0.8035 EN-GJMW-350-4 (GTW35) 0.7070 EN-GJS-700-2 (GGG70), 0.8170 EN-GJMB-700-2 (GTS70)		≤240 HB ≤350 HB	○ ○
Hartguss	-		≤350 HB	○
Neue Gusswerkstoffe GGV	EN-GJV250 (GGV25), EN-GJV350 (GGV35) EN-GJV400 (GGV40), EN-GJV500 (GGV50), SiMo 6		≤220 HB ≤300 HB	○ ○
Neue Gusswerkstoffe ADI	EN-GJS-800-8 (ADI800), EN-GJS-1000-5 (ADI1000) EN-GJS-1200-2 (ADI1200), EN-GJS-1400-1 (ADI1400)	≤1000 ≤1400		○ ○
Sonderlegierungen	Nimonic, Inconel, Monel, Hastelloy	≤2000		●
Titan und Titan-Legierungen	3.7024 Ti99,5, 3.7114 TiAl5Sn2,5, 3.7124 TiCu2 3.7154 TiAl6Zr5, 3.7165 TiAl6V4, 3.7184 TiAl4Mo4Sn2,5, - TiAl8Mo1V1	≤850 ≤1400		● ●
Aluminium und Al-Legierungen	3.0255 Al99,5, 3.2315 AlMgSi1, 3.3515 AlMg1	≤400		○
Al-Knetlegierungen	3.0615 AlMgSiPb, 3.1325 AlCuMg1, 3.3245 AlMg3Si, 3.4365 AlZnMgCu1,5	≤650		○
Al-Gusslegierungen ≤ 10 % Si ≤ 24 % Si	3.2131 G-AlSi5Cu1, 3.2153 G-AlSi7Cu3, 3.2573 G-AlSi9 3.2581 G-AlSi12, 3.2583 G-AlSi12Cu, - G-AlSi12CuNiMg	≤600 ≤600		○ ○
Magnesium-Legierungen	3.5200 MgMn2, 3.5812.05 G-MgAl8Zn1, 3.5612.05 G-MgAl6Zn1	≤400		○
Kupfer, niedriglegiert	2.0070 SE-Cu, 2.1020 CuSn6, 2.1096 G-CuSn5ZnPb	≤500		○
Messing, kurzspanend langspanend	2.0380 CuZn39Pb2, 2.0401 CuZn39Pb3, 2.0410 CuZn43Pb2 2.0250 CuZn20, 2.0280 CuZn33, 2.0332 CuZn37Pb0,5	≤600 ≤600		○ ○
Bronzen, kurzspanend	2.1090 CuSn7ZnPb, 2.1170 CuPb5Sn5, 2.1176 CuPb10Sn 2.0790 CuNi18Zn19Pb	≤600 ≤850		○ ○
Bronzen, langspanend	2.0916 CuAl5, 2.0960 CuAl9Mn, 2.1050 CuSn10 2.0980 CuAl11Ni, 2.1247 CuBe2	≤850 ≤1000		○ ○
Kunststoffe, duroplastisch thermoplastisch	Bakelit, Resopal, Pertinax, Moltopren Plexiglas, Hostalen, Novodur, Makralon	≤150 ≤100		○ ○
aramidfaserverstärkt	Kevlar	≤1000		○
glas-/kohlefaserverstärkt	GFK/CFK	≤1000		○

DAS HARTNER PROGRAMM



▼ FU 500 / FN 500



▼ TIEFLOCHBOHRER



▼ INOX-BOHRER



▼ KLEINSTBOHRER

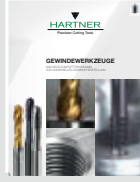

▼ GEWINDEWERKZEUGE



▼ TS-DRILLS



▼ TF 100 MULTI-MILL

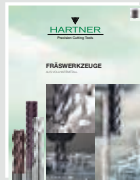

▼ VHM-FRÄSWERKZEUGE

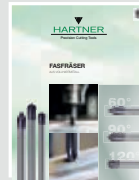

▼ FASFRÄSER



▼ MULTIPLEX



▼ MULTIPLEX HPC



▼ TM-WERKZEUG-
AUSGABESYSTEME

HARTNER GMBH

Postfach 10 04 25 | 72425 Albstadt | Deutschland
Telefon +49 74 31 125-0 | Fax +49 74 31 125-21 547

www.hartner.de

Schnyder + Minder AG
Zielmattenring 11
5H-4563 Gerlafingen
Phone: +41 31 832 77 00
info@smtools.ch

www.smtools.ch

SM[★]TOOLS[®]

Eventuelle Druckfehler oder zwischenzeitlich eingetretene Änderungen vorbehalten, nicht zu Ansprüchen.
Wir liefern ausschließlich zu unseren Liefer- und Zahlungsbedingungen. Diese können bei uns angefordert werden.

146 992/19009-VIII-25 | Gedruckt in Deutschland | 2019

