

HARTNER

Precision Cutting Tools

MULTIPLEX

WECHSELPLATTEN-BOHRSYSTEM MIT INNENKÜHLUNG

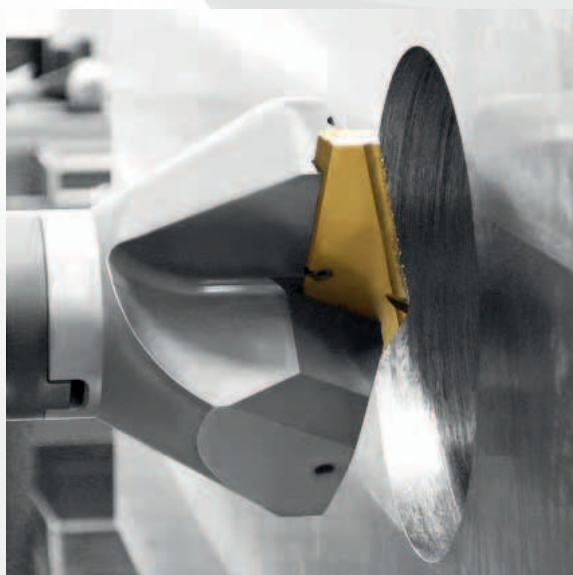

+ Ausgabe 2022 + optimierte Halterausführung

P	M	K	N	S	H	Norm	Typ	Schneidstoff	Oberfläche	Schneid- richtung	Innen- kühlung	Bohrtiefe	d1/mm	Artikel-Nr.	Progr. Seite
---	---	---	---	---	---	------	-----	--------------	------------	----------------------	-------------------	-----------	-------	-------------	-----------------

Multiplex-Halter mit Zylinderschaft



Werksnorm	Ni	rechts	mit	3xD	9,500 - 54,000	86612	7
-----------	----	--------	-----	-----	----------------	--------------	---



Werksnorm	Ni	rechts	mit	5xD	9,500 - 54,000	86622	8
-----------	----	--------	-----	-----	----------------	--------------	---



Werksnorm	Ni	rechts	mit	7xD	9,500 - 54,000	86624	9
-----------	----	--------	-----	-----	----------------	--------------	---



Werksnorm	Ni	rechts	mit		13,157 - 89,845	86628	10
-----------	----	--------	-----	--	-----------------	--------------	----

Multiplex-Halter mit Morsekegel



Werksnorm	Ni	rechts	mit		9,500 - 22,000	86630	13
-----------	----	--------	-----	--	----------------	--------------	----



Werksnorm	Ni	rechts	mit		9,500 - 22,000	86650	14
-----------	----	--------	-----	--	----------------	--------------	----



Werksnorm	B	rechts	mit		24,000 - 89,000	86670	15
-----------	---	--------	-----	--	-----------------	--------------	----



Werksnorm	B	rechts	mit		24,000 - 89,000	86680	16
-----------	---	--------	-----	--	-----------------	--------------	----



Werksnorm	Ni	rechts	mit		34,393 - 89,844	86678	17
-----------	----	--------	-----	--	-----------------	--------------	----

P	M	K	N	S	H	Norm	Typ	Schneidstoff	Oberfläche	Schneid- richtung	Innen- kühlung	Bohrtiefe	d1/mm	Artikel-Nr.	Progr. Seite
---	---	---	---	---	---	------	-----	--------------	------------	----------------------	-------------------	-----------	-------	-------------	-----------------

Wechselplatten



•	○	•	○	○		Werksnorm		HSS-E-PM		rechts			10,000 - 25,000	86602	20
---	---	---	---	---	--	-----------	--	-----------------	--	--------	--	--	-----------------	--------------	----



○	•	○	•	•		Werksnorm		HSS-E		rechts			25,000 - 102,000	86605	21
---	---	---	---	---	--	-----------	--	--------------	--	--------	--	--	------------------	--------------	----



•	○	•	○	○		Werksnorm		HSS-E-PM		rechts			10,000 - 25,000	86608	22
---	---	---	---	---	--	-----------	--	-----------------	--	--------	--	--	-----------------	--------------	----



•	○	•	○	○		Werksnorm		HSS-E-PM		rechts			25,000 - 210,000	86609	23
---	---	---	---	---	--	-----------	--	-----------------	--	--------	--	--	------------------	--------------	----



•	○	•	○	○		Werksnorm		HSS-E-PM		rechts			10,000 - 65,000	86611	24
---	---	---	---	---	--	-----------	--	-----------------	--	--------	--	--	-----------------	--------------	----



•	○	•	○	○		Werksnorm		VHM		rechts			10,000 - 35,000	86701	26
---	---	---	---	---	--	-----------	--	------------	--	--------	--	--	-----------------	--------------	----



•	○	•	○	○		Werksnorm		VHM		rechts			10,000 - 35,000	86702	27
---	---	---	---	---	--	-----------	--	------------	--	--------	--	--	-----------------	--------------	----



•	○	•	○	○		Werksnorm		VHM		rechts			10,000 - 35,000	86708	28
---	---	---	---	---	--	-----------	--	------------	--	--------	--	--	-----------------	--------------	----



•	○	•	○	○		Werksnorm		VHM		rechts			10,000 - 35,000	86709	29
---	---	---	---	---	--	-----------	--	------------	--	--------	--	--	-----------------	--------------	----



			•			Werksnorm		VHM	○	rechts			10,000 - 65,000	86711	30
--	--	--	---	--	--	-----------	--	------------	---	--------	--	--	-----------------	--------------	----

P	M	K	N	S	H	Norm	Typ	Schneidstoff	Oberfläche	Schneid- richtung	Innen- kühlung	Bohrtiefe	d1/mm	Artikel-Nr.	Progr. Seite
---	---	---	---	---	---	------	-----	--------------	------------	----------------------	-------------------	-----------	-------	-------------	-----------------

Kühlmittelzuführringe



Werksnorm

31,750 - 63,500

86690

32

Kühlmittelzuführrohre



Werksnorm



13,160 - 20,960

82571

33

Schnellverschlusskupplung



Werksnorm

9,000 - 13,000

82578

34

Torx-Schraubendreher



Werksnorm

6,001 - 25,001

86842

35

Klemmschrauben für Wechselplatten



Werksnorm

2,000 - 5,000

86807

36

P	M	K	N	S	H	Norm	Typ	Schneidstoff	Oberfläche	Schneid- richtung	Innen- kühlung	Bohrtiefe	d1/mm	Artikel-Nr.	Progr. Seite
---	---	---	---	---	---	------	-----	--------------	------------	----------------------	-------------------	-----------	-------	-------------	-----------------

Kühlmittelzuführfutter für Multiplex



Werksnorm

Ⓑ

86691

37



Werksnorm

Ⓑ

86692

38



Werksnorm

Ⓑ

86693

39



Werksnorm

Ⓑ

86694

40

Reduzierhülsen für Kühlmittelzuführfutter



Werksnorm

Ⓑ

86699

41

MULTIPLEX-HALTER MIT ZYLINDERSCHAFT





Multiplex-Halter mit Zylinderschaft

Artikel-Nr. 86612



vernickelt • Halter für Wechselplatten. Der Halter mit Zylinderschaft besitzt eine innere Kühlmittelzufuhr. Weite Spannuten gewährleisten einen optimalen Spantransport. Einfaches Wechseln der Schneidplatten durch Klemmschrauben. Kein Einjustieren der Wechselplatten nötig. Mit dem Wechselplatten-Spiralbohrer soll grundsätzlich ins volle Material gebohrt werden. Zum Aufbohren vorgegossener oder vorgebohrter Löcher ist dieses Werkzeug nicht geeignet. Spannschrauben Artikel-Nr. 86807 enthalten.

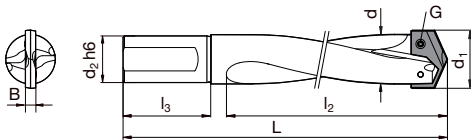

d1 mm	d mm	d2 mm	L mm	l2 mm	l3 mm	B mm	G	Code-Nr.
10,00-11,7	9,500	20,000	108,000	50,000	40,000	2,500	86807 2.000	9,500
11,71-13,4	11,500	20,000	109,000	53,000	40,000	2,500	86807 2.000	11,500
13,41-16,4	13,000	20,000	116,000	60,000	40,000	3,500	86807 2.500	13,000
16,41-18,9	16,000	20,000	118,000	65,000	40,000	3,500	86807 2.501	16,000
18,91-22,4	18,500	20,000	124,000	73,000	40,000	4,000	86807 3.000	18,500
22,41-25,4	22,000	20,000	127,000	78,000	40,000	4,000	86807 3.001	22,000
25,41-29,0	24,000	32,000	178,000	105,000	60,000	5,000	86807 3.500	24,000
29,01-35,0	28,000	32,000	178,000	108,000	60,000	5,000	86807 3.500	28,000
35,01-45,0	34,000	32,000	223,000	152,000	60,000	7,000	86807 4.001	34,000
45,01-55,0	44,000	40,000	233,000	152,000	70,000	7,000	86807 4.001	44,000
55,01-65,0	54,000	40,000	233,000	152,000	70,000	7,000	86807 4.001	54,000



Multiplex-Halter mit Zylinderschaft

Artikel-Nr. 86622



vernickelt • Halter für Wechselplatten. Der Halter mit Zylinderschaft besitzt eine innere Kühlmittelzufuhr. Weite Spannuten gewährleisten einen optimalen Spantransport. Einfaches Wechseln der Schneidplatten durch Klemmschrauben. Kein Einjustieren der Wechselplatten nötig. Mit dem Wechselplatten-Spiralbohrer soll grundsätzlich ins volle Material gebohrt werden. Zum Aufbohren vorgegossener oder vorgebohrter Löcher ist dieses Werkzeug nicht geeignet. Spannschrauben Artikel-Nr. 86807 enthalten.

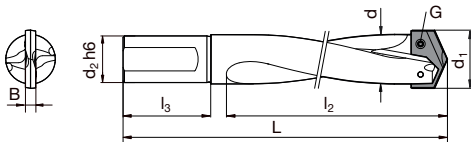

d1 mm	d mm	d2 mm	L mm	l2 mm	l3 mm	B mm	G	Code-Nr.
10,00-11,7	9,500	20,000	140,000	83,000	40,000	2,500	86807 2.000	9,500
11,71-13,4	11,500	20,000	150,000	94,000	40,000	2,500	86807 2.000	11,500
13,41-16,4	13,000	20,000	160,000	104,000	40,000	3,500	86807 2.500	13,000
16,41-18,9	16,000	20,000	170,000	117,000	40,000	3,500	86807 2.501	16,000
18,91-22,4	18,500	20,000	180,000	129,000	40,000	4,000	86807 3.000	18,500
22,41-25,4	22,000	20,000	180,000	131,000	40,000	4,000	86807 3.001	22,000
25,41-29,0	24,000	32,000	240,000	166,000	60,000	5,000	86807 3.500	24,000
29,01-35,0	28,000	32,000	240,000	170,000	60,000	5,000	86807 3.500	28,000
35,01-45,0	34,000	32,000	280,000	210,000	60,000	7,000	86807 4.001	34,000
45,01-55,0	44,000	40,000	290,000	210,000	70,000	7,000	86807 4.001	44,000
55,01-65,0	54,000	40,000	290,000	210,000	70,000	7,000	86807 4.001	54,000



Multiplex-Halter mit Zylinderschaft

Artikel-Nr. 86624



vernickelt • Halter für Wechselplatten. Der Halter mit Zylinderschaft besitzt eine innere Kühlmittelzufuhr. Weite Spannuten gewährleisten einen optimalen Spantransport. Einfaches Wechseln der Schneidplatten durch Klemmschrauben. Kein Einjustieren der Wechselplatten nötig. Mit dem Wechselplatten-Spiralbohrer soll grundsätzlich ins volle Material gebohrt werden. Zum Aufbohren vorgegossener oder vorgebohrter Löcher ist dieses Werkzeug nicht geeignet. Spannschrauben Artikel-Nr. 86807 enthalten.

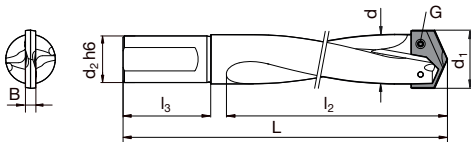

d1 mm	d mm	d2 mm	L mm	l2 mm	l3 mm	B mm	G	Code-Nr.
10,00-11,7	9,500	20,000	180,000	123,000	40,000	2,500	86807 2.000	9,500
11,71-13,4	11,500	20,000	190,000	134,000	40,000	2,500	86807 2.000	11,500
13,41-16,4	13,000	20,000	210,000	155,000	40,000	3,500	86807 2.500	13,000
16,41-18,9	16,000	20,000	220,000	168,000	40,000	3,500	86807 2.501	16,000
18,91-22,4	18,500	20,000	250,000	199,000	40,000	4,000	86807 3.000	18,500
22,41-25,4	22,000	20,000	250,000	201,000	40,000	4,000	86807 3.001	22,000
25,41-29,0	24,000	32,000	320,000	246,000	60,000	5,000	86807 3.500	24,000
29,01-35,0	28,000	32,000	320,000	250,000	60,000	5,000	86807 3.500	28,000
35,01-45,0	34,000	32,000	380,000	310,000	60,000	7,000	86807 4.001	34,000
45,01-55,0	44,000	40,000	390,000	310,000	70,000	7,000	86807 4.001	44,000
55,01-65,0	54,000	40,000	390,000	310,000	70,000	7,000	86807 4.001	54,000



Multiplex-Halter mit Zylinderschaft

Artikel-Nr. 86628



vernickelt • Halter für Wechselplatten. Der überlange Halter mit Zylinderschaft besitzt eine innere Kühlmittelzufuhr. Weite Spannuten gewährleisten einen optimalen Spantransport. Einfaches Wechseln der Schneidplatten durch Klemmschrauben. Kein Einstellen der Wechselplatten nötig. Mit dem Wechselplatten-Spiralbohrer soll grundsätzlich ins volle Material gebohrt werden. Zum Aufbohren vorgegessener oder vorgebohrter Löcher ist dieses Werkzeug nicht geeignet. Spannschrauben Artikel-Nr. 86807 enthalten

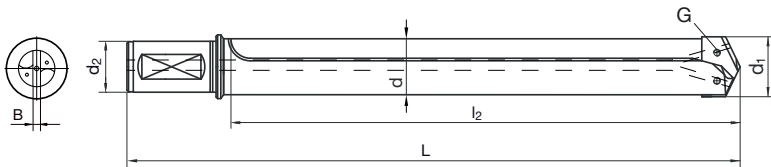

d1 mm	d mm	d2 mm	L mm	l2 mm	B mm	G	Code-Nr.
13,41-16,4	13,000	20,000	198,500	156,500	3,500	86807 2.500	13,157
13,41-16,4	13,000	20,000	238,500	196,500	3,500	86807 2.500	13,197
13,41-16,4	13,000	20,000	318,500	276,500	3,500	86807 2.500	13,277
15,00-16,4	14,500	20,000	95,000	52,000	3,500	86807 2.500	14,052
15,00-16,4	14,500	20,000	125,000	82,000	3,500	86807 2.500	14,082
15,00-16,4	14,500	20,000	178,500	136,500	3,500	86807 2.500	14,137
15,00-16,4	14,500	20,000	198,500	156,500	3,500	86807 2.500	14,157
15,00-16,4	14,500	20,000	238,500	196,500	3,500	86807 2.500	14,197
15,00-16,4	14,500	20,000	268,500	226,500	3,500	86807 2.500	14,227
15,00-16,4	14,500	20,000	398,500	356,500	3,500	86807 2.500	14,357
16,41-18,9	16,000	20,000	260,500	218,500	3,500	86807 2.500	16,219
16,41-18,9	16,000	20,000	295,500	253,500	3,500	86807 2.500	16,254
16,41-18,9	16,000	20,000	410,500	368,500	3,500	86807 2.501	16,369
18,91-22,4	18,500	20,000	304,000	262,000	4,000	86807 3.000	18,262
18,91-22,4	18,500	20,000	344,000	302,000	4,000	86807 3.000	18,302
18,91-22,4	18,500	20,000	464,000	422,000	4,000	86807 3.000	18,422
22,41-25,4	22,000	20,000	285,000	243,000	4,000	86807 3.001	22,243
22,41-25,4	22,000	20,000	345,000	303,000	4,000	86807 3.001	22,303
22,41-25,4	22,000	20,000	385,000	343,000	4,000	86807 3.001	22,343
22,41-25,4	22,000	20,000	535,000	493,000	4,000	86807 3.001	22,493
25,41-29,0	23,000	32,000	138,000	63,000	5,000	86807 3.500	23,063
25,41-29,0	23,000	32,000	173,000	98,000	5,000	86807 3.500	23,098
25,41-29,0	23,000	32,000	225,000	150,000	5,000	86807 3.500	23,150
25,41-29,0	23,000	32,000	273,000	198,000	5,000	86807 3.500	23,198
25,41-29,0	23,000	32,000	343,000	268,000	5,000	86807 3.500	23,268
25,41-29,0	23,000	32,000	433,000	358,000	5,000	86807 3.500	23,358
25,41-29,0	23,000	32,000	503,000	428,000	5,000	86807 3.500	23,428
25,41-29,0	23,000	32,000	683,000	608,000	5,000	86807 3.500	23,608
29,01-35,0	28,000	32,000	393,000	321,500	5,000	86807 3.500	28,322
29,01-35,0	28,000	32,000	473,000	401,500	5,000	86807 3.500	28,402
29,01-35,0	28,000	32,000	553,000	481,500	5,000	86807 3.500	28,482
29,01-35,0	28,000	32,000	763,000	691,500	5,000	86807 3.500	28,692
33,20-36,0	33,000	32,000	148,000	80,500	5,000	86807 3.500	33,081
33,20-36,0	33,000	32,000	173,000	105,500	5,000	86807 3.500	33,106
33,20-36,0	33,000	32,000	223,000	155,500	5,000	86807 3.500	33,156
33,20-36,0	33,000	32,000	273,000	205,500	5,000	86807 3.500	33,206
33,20-36,0	33,000	32,000	393,000	325,500	5,000	86807 3.500	33,326
33,20-36,0	33,000	32,000	503,000	435,500	5,000	86807 3.500	33,436
33,20-36,0	33,000	32,000	603,000	535,500	5,000	86807 3.500	33,536
33,20-36,0	33,000	32,000	823,000	755,500	5,000	86807 3.500	33,756
35,01-45,0	34,000	32,000	457,000	388,000	7,000	86807 4.001	34,388
35,01-45,0	34,000	32,000	607,000	538,000	7,000	86807 4.001	34,538



Multiplex-Halter mit Zylinderschaft

d1 mm	d mm	d2 mm	L mm	l2 mm	B mm	G	Code-Nr.
35,01-45,0	34,000	32,000	907,000	838,000	7,000	86807 4.001	34,838
45,01-55,0	44,000	40,000	467,000	394,000	7,000	86807 4.001	44,394
45,01-55,0	44,000	40,000	617,000	544,000	7,000	86807 4.001	44,544
45,01-55,0	44,000	40,000	917,000	844,000	7,000	86807 4.001	44,844
55,01-65,0	54,000	40,000	467,000	393,000	7,000	86807 4.001	54,393
55,01-65,0	54,000	40,000	617,000	543,000	7,000	86807 4.001	54,543
55,01-65,0	54,000	40,000	917,000	843,000	7,000	86807 4.001	54,843
65,01-78,0	63,000	40,000	230,000	155,000	9,000	86807 5.000	63,155
65,01-78,0	63,000	40,000	340,000	265,000	9,000	86807 5.000	63,265
65,01-78,0	63,000	40,000	470,000	395,000	9,000	86807 5.000	63,395
65,01-78,0	63,000	40,000	620,000	545,000	9,000	86807 5.000	63,545
65,01-78,0	63,000	40,000	920,000	845,000	9,000	86807 5.000	63,845
78,01-90,0	77,000	50,000	240,000	155,000	9,000	86807 5.000	77,155
78,01-90,0	77,000	50,000	350,000	265,000	9,000	86807 5.000	77,265
78,01-90,0	77,000	50,000	480,000	395,000	9,000	86807 5.000	77,395
78,01-90,0	77,000	50,000	630,000	545,000	9,000	86807 5.000	77,545
78,01-90,0	77,000	50,000	930,000	845,000	9,000	86807 5.000	77,845
90,01-102,0	89,000	50,000	240,000	155,000	9,000	86807 5.000	89,155
90,01-102,0	89,000	50,000	350,000	265,000	9,000	86807 5.000	89,265
90,01-102,0	89,000	50,000	480,000	395,000	9,000	86807 5.000	89,395
90,01-102,0	89,000	50,000	630,000	545,000	9,000	86807 5.000	89,545
90,01-102,0	89,000	50,000	930,000	845,000	9,000	86807 5.000	89,845

MULTIPLEX-HALTER MIT MORSEKEGEL





Multiplex-Halter mit Morsekegel

Artikel-Nr. 86630



vernickelt • Halter für Wechselplatten in kurzer Ausführung. Der Halter mit Kegelschaft besitzt eine innere Kühlmittelzufuhr. Weite Spannuten gewährleisten einen optimalen Spantransport. Einfaches Wechseln der Schneidplatten durch Klemmschrauben. Kein Einstellen der Wechselplatten nötig. Mit dem Wechselplatten-Spiralbohrer soll grundsätzlich ins volle Material gebohrt werden. Zum Aufbohren vorgegossener oder vorgebohrter Löcher ist dieses Werkzeug nicht geeignet.

Kühlmittelzuführung: axial (radial auf Anfrage)

Spannschrauben Artikel-Nr. 86807 enthalten

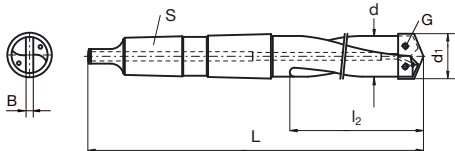

d1 mm	d mm	S	L mm	l ₂ mm	B mm	G	Code-Nr.
10,00-11,7	9,500	MK-2	139,000	56,000	2,500	86807 2.000	9,500
11,71-13,4	11,500	MK-2	141,000	58,000	2,500	86807 2.000	11,500
13,41-16,4	13,000	MK-2	148,000	63,000	3,500	86807 2.500	13,000
16,41-18,9	16,000	MK-2	150,000	67,000	3,500	86807 2.501	16,000
18,91-22,4	18,500	MK-3	178,000	76,000	4,000	86807 3.000	18,500
22,41-25,4	22,000	MK-3	181,000	80,000	4,000	86807 3.001	22,000



Multiplex-Halter mit Morsekegel

Artikel-Nr. 86650



vernickelt • Halter für Wechselplatten in langer Ausführung. Der Halter mit Kegelschaft besitzt eine innere Kühlmittelzufuhr. Weite Spannuten gewährleisten einen optimalen Spantransport. Einfaches Wechseln der Schneidplatten durch Klemmschrauben. Kein Einstellen der Wechselplatten nötig. Mit dem Wechselplatten-Spiralbohrer soll grundsätzlich ins volle Material gebohrt werden. Zum Aufbohren vorgegossener oder vorgebohrter Löcher ist dieses Werkzeug nicht geeignet.
 Kühlmittelzuführung: axial (radial auf Anfrage)
 Spannschrauben Artikel-Nr. 86807 enthalten

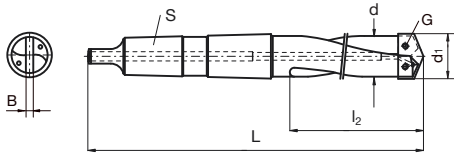

d1 mm	d mm	S	L mm	l2 mm	B mm	G	Code-Nr.
10,00-11,7	9,500	MK-2	186,000	103,000	2,500	86807 2.000	9,500
11,71-13,4	11,500	MK-2	191,000	108,000	2,500	86807 2.000	11,500
13,41-16,4	13,000	MK-2	210,000	125,000	3,500	86807 2.500	13,000
16,41-18,9	16,000	MK-2	218,000	135,000	3,500	86807 2.501	16,000
18,91-22,4	18,500	MK-3	258,000	156,000	4,000	86807 3.000	18,500
22,41-25,4	22,000	MK-3	266,000	166,000	4,000	86807 3.001	22,000



Multiplex-Halter mit Morsekegel

Artikel-Nr. 86670



≤ Ø 28 mm: vernickelt, > Ø 28 mm: brüniert • Halter für Wechselplatten in kurzer Ausführung mit Ringlauffläche für Kühlmittelzuführung. Der Halter mit Kegelschaft besitzt eine innere Kühlmittelzufuhr. Weite Spannuten gewährleisten einen optimalen Spantransport. Einfaches Wechseln der Schneidplatten durch Klemmschrauben. Kein Einjustieren der Wechselplatten nötig. Mit dem Wechselplatten-Spiralbohrer soll grundsätzlich ins volle Material gebohrt werden. Zum Aufbohren vorgegossener oder vorgebohrter Löcher ist dieses Werkzeug nicht geeignet.

Kühlmittelzuführung: radial (axial auf Anfrage)

Ab Halter-Ø 63,0 mm: gerade genutet

Schaftgröße MK 5: mit Querkeilnut

Spannschrauben Artikel-Nr. 86807 enthalten

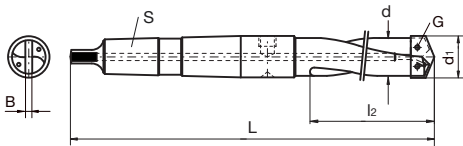

d1 mm	d mm	S	L mm	l2 mm	B mm	G	Code-Nr.
25.01-29.0	24,000	MK-4	279,000	108,000	5,000	86807 3.500	24,000
29.01-35.0	28,000	MK-4	279,000	108,000	5,000	86807 3.500	28,000
35.01-45.0	34,000	MK-4	324,000	152,000	7,000	86807 4.001	34,000
45.01-55.0	44,000	MK-4	324,000	152,000	7,000	86807 4.001	44,000
55.01-65.0	54,000	MK-4	324,000	152,000	7,000	86807 4.001	54,000
65.01-78.0	63,000	MK-5	436,000	216,000	9,000	86807 5.000	63,000
78.01-90.0	77,000	MK-5	436,000	216,000	9,000	86807 5.000	77,000
90.01-102.0	89,000	MK-5	436,000	216,000	9,000	86807 5.000	89,000



Multiplex-Halter mit Morsekegel

Artikel-Nr. 86680



≤ Ø 28 mm: vernickelt, > Ø 28 mm: brüniert • Halter für Wechselplatten in langer Ausführung mit Ringlauffläche für Kühlmittelzuführung. Der Halter mit Kegelschaft besitzt eine innere Kühlmittelzufuhr. Weite Spannuten gewährleisten einen optimalen Spantransport. Einfaches Wechseln der Schneidplatten durch Klemmschrauben. Kein Einstellen der Wechselplatten nötig. Mit dem Wechselplatten-Spiralbohrer soll grundsätzlich ins volle Material gebohrt werden. Zum Aufbohren vorgegossener oder vorgebohrter Löcher ist dieses Werkzeug nicht geeignet.

Kühlmittelzuführung: radial (axial auf Anfrage)

Ab Halter-Ø 63,0 mm: gerade genutet

Schaftgröße MK 5: mit Querkeilnut

Spannschrauben Artikel-Nr. 86807 enthalten

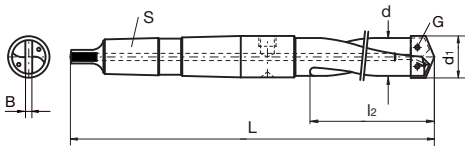

d1 mm	d mm	S	L mm	l2 mm	B mm	G	Code-Nr.
25.01-29.0	24,000	MK-4	379,000	208,000	5,000	86807 3.500	24,000
29.01-35.0	28,000	MK-4	379,000	208,000	5,000	86807 3.500	28,000
35.01-45.0	34,000	MK-4	429,000	257,000	7,000	86807 4.001	34,000
45.01-55.0	44,000	MK-4	429,000	257,000	7,000	86807 4.001	44,000
55.01-65.0	54,000	MK-4	429,000	257,000	7,000	86807 4.001	54,000
65.01-78.0	63,000	MK-5	536,000	316,000	9,000	86807 5.000	63,000
78.01-90.0	77,000	MK-5	536,000	316,000	9,000	86807 5.000	77,000
90.01-102.0	89,000	MK-5	536,000	316,000	9,000	86807 5.000	89,000



HARTNER

Multiplex-Halter mit Morsekegel

Artikel-Nr. 86678



Oberfläche ≤ 1000 mm Gesamtlänge vernickelt, > 1000 mm Gesamtlänge brüniert • Halter für Wechselplatten in überlanger Ausführung. Der Halter mit Kegelschaft besitzt eine innere Kühlmittelzufuhr. Weite Spannuten gewährleisten einen optimalen Spantransport. Einfaches Wechseln der Schneidplatten durch Klemmschrauben. Kein Einstellen der Wechselplatten nötig. Mit dem Wechselplatten-Spiralbohrer soll grundsätzlich ins volle Material gebohrt werden. Zum Aufbohren vorgegossener oder vorgebohrter Löcher ist dieses Werkzeug nicht geeignet.

Kühlmittelzuführung: radial (axial auf Anfrage)

Spannschrauben Artikel-Nr. 86807 enthalten



d1 mm	d mm	S	L mm	l2 mm	B mm	G	Code-Nr.
35,01-45,0	34,000	MK-4	566,000	393,000	7,000	86807 4.001	34,393
35,01-45,0	34,000	MK-4	716,000	543,000	7,000	86807 4.001	34,543
35,01-45,0	34,000	MK-4	1016,000	843,000	7,000	86807 4.001	34,843
45,01-55,0	44,000	MK-4	716,000	544,500	7,000	86807 4.001	44,545
45,01-55,0	44,000	MK-4	1016,000	844,500	7,000	86807 4.001	44,845
55,01-65,0	54,000	MK-4	560,000	387,000	7,000	86807 4.001	54,387
55,01-65,0	54,000	MK-4	716,000	543,000	7,000	86807 4.001	54,543
55,01-65,0	54,000	MK-4	1016,000	843,000	7,000	86807 4.001	54,843
65,01-78,0	63,000	MK-5	766,000	547,000	9,000	86807 5.000	63,547
65,01-78,0	63,000	MK-5	1066,000	847,000	9,000	86807 5.000	63,847
78,01-90,0	77,000	MK-5	766,000	544,000	9,000	86807 5.000	77,544
78,01-90,0	77,000	MK-5	1066,000	844,000	9,000	86807 5.000	77,844
90,01-102,0	89,000	MK-5	766,000	544,000	9,000	86807 5.000	89,544
90,01-102,0	89,000	MK-5	1066,000	844,000	9,000	86807 5.000	89,844



Sonderprogramm Multiplex Modular-System Ø 97 mm bis 210 mm



Aufnahmen

Folgende Versionen sind auf Anfrage lieferbar:

- SK50 DIN ISO 7388-1 mit Kühlmittelring

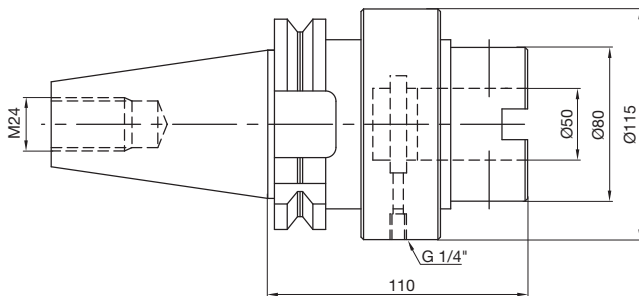

- SK50 DIN ISO 7388-1 ohne Kühlmittelring

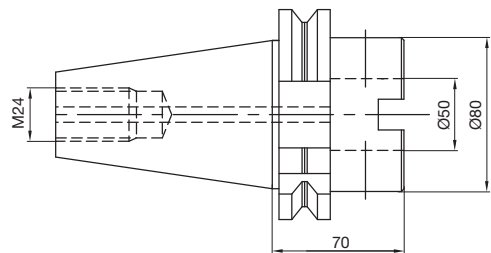

- SK50 DIN 2080 mit Kühlmittelring

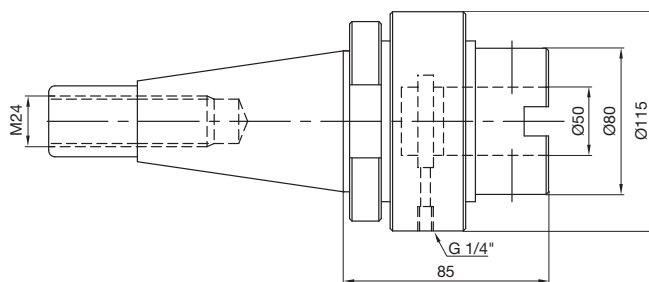

- SK50 DIN 2080 ohne Kühlmittelring

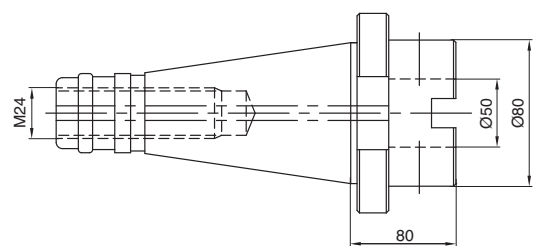

- MK 5/MK 6 mit Kühlmittelring

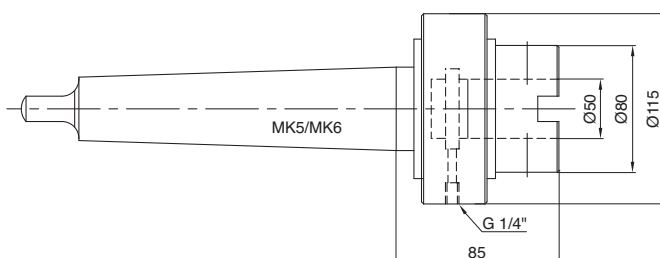

- MK 5/MK 6 ohne Kühlmittelring

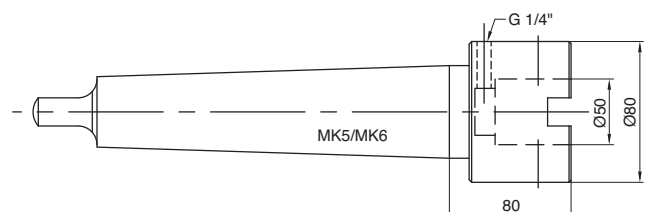



Sonderprogramm Multiplex Modular-System Ø 97 mm bis 210 mm

Verlängerungen für Bohrkopf

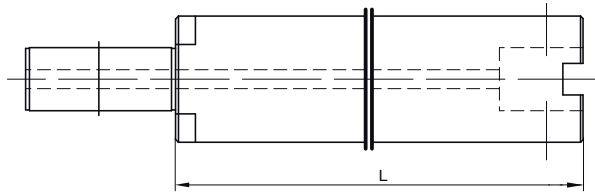

Verlängerungen für Bohrkopf
 Ø 97 mm - Ø 130 mm*
 L = 186 mm
 L = 300 mm

Verlängerungen für Bohrkopf
 Ø 131 mm - Ø 165 mm und Ø 164 mm - Ø 210 mm
 L = 204 mm
 L = 300 mm
 L = 500 mm

Mitnehmer



klein, für Bohrkopf Ø 97 mm - Ø 130 mm,
 Breite 14 mm

groß, für Bohrkopf Ø 131 mm - Ø 165 mm
 und Ø 164 mm - Ø 210 mm, Breite 16 mm

Bohrköpfe

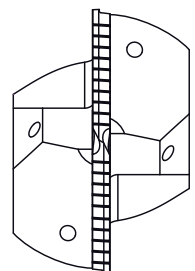
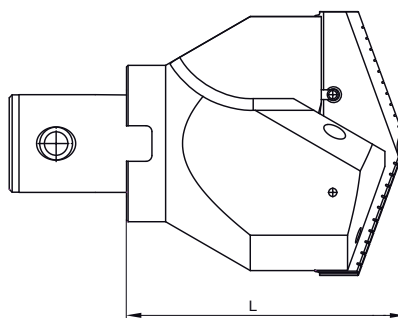
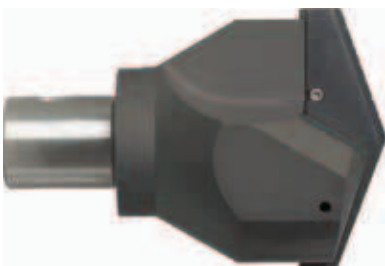

Folgende Größen sind auf Anfrage lieferbar:

- Ø 97 mm bis Ø 130 mm, L = 118,5 mm*
- Ø 131 mm bis Ø 165 mm, L = 142,5 mm
- Ø 164 mm bis Ø 210 mm, L = 142,5 mm

* Reduzierung erforderlich



HARTNER

Wechselplatten

Artikel-Nr. 86602



P	M	K	N	S	H
•	○	•	○		



Ausspitzung $\geq \varnothing 9,800$ • Wechselplatte mit Spanteilernuten. Spitzenwinkel 135°. Für universelle Anwendung.

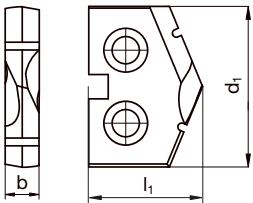

d1 mm	l1 mm	b mm	Code-Nr.	d1 mm	l1 mm	b mm	Code-Nr.
10,000	8,700	2,500	10,000	18,000	11,700	3,500	18,000
10,200	8,700	2,500	10,200	18,250	11,700	3,500	18,250
10,500	8,700	2,500	10,500	18,500	11,700	3,500	18,500
11,000	8,700	2,500	11,000	18,750	11,700	3,500	18,750
11,110	8,700	2,500	11,110	19,000	13,700	4,000	19,000
11,500	8,700	2,500	11,500	19,500	13,700	4,000	19,500
11,750	8,700	2,500	11,750	19,750	13,700	4,000	19,750
12,000	8,700	2,500	12,000	20,000	13,700	4,000	20,000
12,300	8,700	2,500	12,300	20,250	13,700	4,000	20,250
12,500	8,700	2,500	12,500	20,500	13,700	4,000	20,500
12,750	8,700	2,500	12,750	21,000	13,700	4,000	21,000
13,000	8,700	2,500	13,000	21,250	13,700	4,000	21,250
13,250	8,700	2,500	13,250	21,500	13,700	4,000	21,500
13,500	11,700	3,500	13,500	21,750	13,700	4,000	21,750
13,750	11,700	3,500	13,750	22,000	13,700	4,000	22,000
14,000	11,700	3,500	14,000	22,500	13,700	4,000	22,500
14,250	11,700	3,500	14,250	23,000	13,700	4,000	23,000
14,500	11,700	3,500	14,500	23,500	13,700	4,000	23,500
14,750	11,700	3,500	14,750	24,000	13,700	4,000	24,000
15,000	11,700	3,500	15,000	24,500	13,700	4,000	24,500
15,250	11,700	3,500	15,250	24,750	13,700	4,000	24,750
15,500	11,700	3,500	15,500	25,000	13,700	4,000	25,000
15,750	11,700	3,500	15,750				
16,000	11,700	3,500	16,000				
16,500	11,700	3,500	16,500				
16,750	11,700	3,500	16,750				
17,000	11,700	3,500	17,000				
17,250	11,700	3,500	17,250				
17,500	11,700	3,500	17,500				
17,750	11,700	3,500	17,750				



Wechselplatten

Artikel-Nr. 86605



P	M	K	N	S	H
○	●	○	●	●	



Ausspitzung $\geq \varnothing 25,000$ • Wechselplatte mit Spanteilemuten. VA-Geometrie für rostfreie Stähle, Aluminium-Legierungen und Nichteisenmetalle.

Spitzenwinkel:

$\geq \varnothing 25,0 \text{ mm} = 132^\circ$

$> \varnothing 66,0 \text{ mm} = 140^\circ$

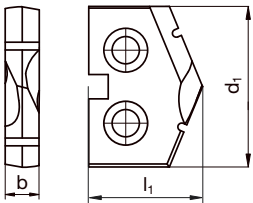

d1 mm	l1 mm	b mm	Code-Nr.	d1 mm	l1 mm	b mm	Code-Nr.
25,000	17,300	5,000	25,000	56,000	24,000	7,000	56,000
25,500	17,300	5,000	25,500	57,000	24,000	7,000	57,000
26,000	17,300	5,000	26,000	58,000	24,000	7,000	58,000
26,500	17,300	5,000	26,500	59,000	24,000	7,000	59,000
27,000	17,300	5,000	27,000	60,000	24,000	7,000	60,000
28,000	17,300	5,000	28,000	62,000	24,000	7,000	62,000
29,000	17,300	5,000	29,000	64,000	24,000	7,000	64,000
29,500	17,300	5,000	29,500	65,000	24,000	7,000	65,000
30,000	17,300	5,000	30,000	66,000	37,000	9,000	66,000
31,000	17,300	5,000	31,000	68,000	37,000	9,000	68,000
32,000	17,300	5,000	32,000	70,000	37,000	9,000	70,000
33,000	17,300	5,000	33,000	74,000	37,000	9,000	74,000
34,000	17,300	5,000	34,000	75,000	37,000	9,000	75,000
35,000	17,300	5,000	35,000	78,000	37,000	9,000	78,000
36,000	24,000	7,000	36,000	80,000	37,000	9,000	80,000
37,000	24,000	7,000	37,000	82,000	37,000	9,000	82,000
37,500	24,000	7,000	37,500	84,000	37,000	9,000	84,000
38,000	24,000	7,000	38,000	85,000	37,000	9,000	85,000
39,000	24,000	7,000	39,000	88,000	37,000	9,000	88,000
40,000	24,000	7,000	40,000	90,000	37,000	9,000	90,000
41,000	24,000	7,000	41,000	94,000	37,000	9,000	94,000
42,000	24,000	7,000	42,000	95,000	37,000	9,000	95,000
43,000	24,000	7,000	43,000	96,000	37,000	9,000	96,000
44,000	24,000	7,000	44,000	98,000	37,000	9,000	98,000
45,000	24,000	7,000	45,000	100,000	37,000	9,000	100,000
46,000	24,000	7,000	46,000	102,000	37,000	9,000	102,000
47,000	24,000	7,000	47,000				
48,000	24,000	7,000	48,000				
49,000	24,000	7,000	49,000				
50,000	24,000	7,000	50,000				
50,500	24,000	7,000	50,500				
51,000	24,000	7,000	51,000				
52,000	24,000	7,000	52,000				
53,000	24,000	7,000	53,000				
54,000	24,000	7,000	54,000				
55,000	24,000	7,000	55,000				



HARTNER

Wechselplatten

Artikel-Nr. 86608



P	M	K	N	S	H
•	○	•	○		

HSS-E-PM



0/+0,05

Ausspitzung $\geq \varnothing 10,000$ • Wechselplatte mit Spanteilemuten. Spitzenwinkel 135°. Für universelle Anwendung.

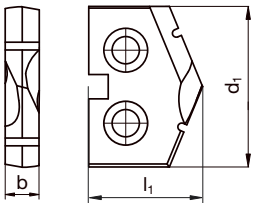

d1 mm	l1 mm	b mm	Code-Nr.	d1 mm	l1 mm	b mm	Code-Nr.
10,000	8,700	2,500	10,000	17,750	11,700	3,500	17,750
10,500	8,700	2,500	10,500	18,000	11,700	3,500	18,000
11,000	8,700	2,500	11,000	18,250	11,700	3,500	18,250
11,500	8,700	2,500	11,500	18,500	11,700	3,500	18,500
11,750	8,700	2,500	11,750	18,750	11,700	3,500	18,750
12,000	8,700	2,500	12,000	19,000	13,700	4,000	19,000
12,500	8,700	2,500	12,500	19,500	13,700	4,000	19,500
12,750	8,700	2,500	12,750	19,750	13,700	4,000	19,750
13,000	8,700	2,500	13,000	20,000	13,700	4,000	20,000
13,250	8,700	2,500	13,250	20,250	13,700	4,000	20,250
13,500	11,700	3,500	13,500	20,500	13,700	4,000	20,500
13,750	11,700	3,500	13,750	21,000	13,700	4,000	21,000
14,000	11,700	3,500	14,000	21,250	13,700	4,000	21,250
14,250	11,700	3,500	14,250	21,500	13,700	4,000	21,500
14,500	11,700	3,500	14,500	21,750	13,700	4,000	21,750
14,750	11,700	3,500	14,750	22,000	13,700	4,000	22,000
15,000	11,700	3,500	15,000	22,500	13,700	4,000	22,500
15,250	11,700	3,500	15,250	23,000	13,700	4,000	23,000
15,500	11,700	3,500	15,500	23,500	13,700	4,000	23,500
15,750	11,700	3,500	15,750	24,000	13,700	4,000	24,000
16,000	11,700	3,500	16,000	24,500	13,700	4,000	24,500
16,500	11,700	3,500	16,500	24,750	13,700	4,000	24,750
17,000	11,700	3,500	17,000	25,000	13,700	4,000	25,000
17,500	11,700	3,500	17,500				



HARTNER

Wechselplatten

Artikel-Nr. 86609



P	M	K	N	S	H
•	○	•	○		



Ausspitzung $\geq \varnothing 25,000$ • Wechselplatte mit Spanteilemuten. Für universelle Anwendung.

Spitzenwinkel:

$\geq \varnothing 25,0$ mm = 132°

$> \varnothing 66,0$ mm = 140°

$> \varnothing 190,0$ mm = 150°

Schneidstoff:

$\leq \varnothing 66,0$ mm HSS-E-PM

$> \varnothing 66,0$ mm HSS-E

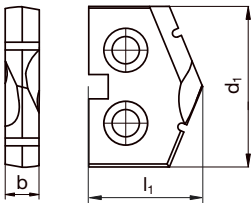

d1 mm	l1 mm	b mm	Code-Nr.	d1 mm	l1 mm	b mm	Code-Nr.
25,000	17,300	5,000	25,000	66,000	37,000	9,000	66,000
25,500	17,300	5,000	25,500	68,000	37,000	9,000	68,000
26,000	17,300	5,000	26,000	70,000	37,000	9,000	70,000
26,500	17,300	5,000	26,500	74,000	37,000	9,000	74,000
27,000	17,300	5,000	27,000	75,000	37,000	9,000	75,000
28,000	17,300	5,000	28,000	78,000	37,000	9,000	78,000
29,000	17,300	5,000	29,000	80,000	37,000	9,000	80,000
29,500	17,300	5,000	29,500	82,000	37,000	9,000	82,000
30,000	17,300	5,000	30,000	84,000	37,000	9,000	84,000
31,000	17,300	5,000	31,000	85,000	37,000	9,000	85,000
32,000	17,300	5,000	32,000	88,000	37,000	9,000	88,000
33,000	17,300	5,000	33,000	90,000	37,000	9,000	90,000
34,000	17,300	5,000	34,000	93,000	37,000	9,000	93,000
35,000	17,300	5,000	35,000	95,000	37,000	9,000	95,000
36,000	24,000	7,000	36,000	96,000	37,000	9,000	96,000
37,000	24,000	7,000	37,000	98,000	37,000	9,000	98,000
38,000	24,000	7,000	38,000	100,000	37,000	9,000	100,000
39,000	24,000	7,000	39,000	102,000	37,000	9,000	102,000
40,000	24,000	7,000	40,000	103,000	37,000	9,000	103,000
41,000	24,000	7,000	41,000	105,000	37,000	9,000	105,000
42,000	24,000	7,000	42,000	110,000	37,000	9,000	110,000
43,000	24,000	7,000	43,000	115,000	37,000	9,000	115,000
44,000	24,000	7,000	44,000	120,000	37,000	9,000	120,000
45,000	24,000	7,000	45,000	125,000	37,000	9,000	125,000
46,000	24,000	7,000	46,000	130,000	37,000	9,000	130,000
47,000	24,000	7,000	47,000	135,000	47,000	9,000	135,000
48,000	24,000	7,000	48,000	140,000	47,000	9,000	140,000
49,000	24,000	7,000	49,000	145,000	47,000	9,000	145,000
50,000	24,000	7,000	50,000	150,000	47,000	9,000	150,000
51,000	24,000	7,000	51,000	155,000	47,000	9,000	155,000
52,000	24,000	7,000	52,000	160,000	47,000	9,000	160,000
53,000	24,000	7,000	53,000	165,000	47,000	9,000	165,000
54,000	24,000	7,000	54,000	170,000	47,000	9,000	170,000
55,000	24,000	7,000	55,000	175,000	47,000	9,000	175,000
56,000	24,000	7,000	56,000	180,000	47,000	9,000	180,000
57,000	24,000	7,000	57,000	185,000	47,000	9,000	185,000
58,000	24,000	7,000	58,000	190,000	47,000	9,000	190,000
59,000	24,000	7,000	59,000	195,000	47,000	9,000	195,000
60,000	24,000	7,000	60,000	200,000	47,000	9,000	200,000
62,000	24,000	7,000	62,000	205,000	47,000	9,000	205,000
64,000	24,000	7,000	64,000	210,000	47,000	9,000	210,000
65,000	24,000	7,000	65,000				



Wechselplatten

Artikel-Nr. 86611



P	M	K	N	S	H
●	○	●	○		

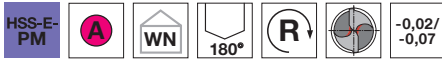

Ausspitzung $\geq \varnothing 10,000$ • Wechselplatte mit Spanteilemuten. Für universelle Anwendung.
 Spitzenwinkel der Zentrierspitze:
 $\leq \varnothing 35,0 \text{ mm} = 120^\circ$
 $> \varnothing 35,0 \text{ mm} = 140^\circ$

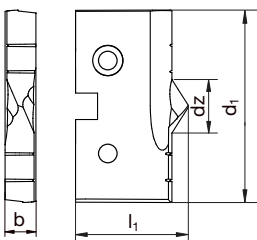

d1 mm	l1 mm	b mm	Code-Nr.	d1 mm	l1 mm	b mm	Code-Nr.
10,000	10,000	2,500	10,000	23,000	15,000	4,000	23,000
10,500	10,000	2,500	10,500	23,500	15,000	4,000	23,500
11,000	10,000	2,500	11,000	24,000	15,000	4,000	24,000
11,500	10,000	2,500	11,500	24,500	15,000	4,000	24,500
11,750	10,000	2,500	11,750	24,750	15,000	4,000	24,750
12,000	10,000	2,500	12,000	25,000	15,000	4,000	25,000
12,500	10,000	2,500	12,500	25,000	18,500	5,000	25,001
12,700	10,000	2,500	12,700	25,400	18,500	5,000	25,400
12,750	10,000	2,500	12,750	25,500	18,500	5,000	25,500
13,000	10,000	2,500	13,000	26,000	18,500	5,000	26,000
13,250	10,000	2,500	13,250	26,500	18,500	5,000	26,500
13,500	13,000	3,500	13,500	27,000	18,500	5,000	27,000
13,750	13,000	3,500	13,750	28,000	18,500	5,000	28,000
14,000	13,000	3,500	14,000	29,000	18,500	5,000	29,000
14,250	13,000	3,500	14,250	29,500	18,500	5,000	29,500
14,500	13,000	3,500	14,500	30,000	18,500	5,000	30,000
14,750	13,000	3,500	14,750	31,000	18,500	5,000	31,000
15,000	13,000	3,500	15,000	32,000	18,500	5,000	32,000
15,250	13,000	3,500	15,250	33,000	18,500	5,000	33,000
15,500	13,000	3,500	15,500	34,000	18,500	5,000	34,000
15,750	13,000	3,500	15,750	35,000	18,500	5,000	35,000
16,000	13,000	3,500	16,000	36,000	25,500	7,000	36,000
16,500	13,000	3,500	16,500	37,000	25,500	7,000	37,000
17,000	13,000	3,500	17,000	38,000	25,500	7,000	38,000
17,500	13,000	3,500	17,500	39,000	25,500	7,000	39,000
17,750	13,000	3,500	17,750	40,000	25,500	7,000	40,000
18,000	13,000	3,500	18,000	41,000	25,500	7,000	41,000
18,250	13,000	3,500	18,250	42,000	25,500	7,000	42,000
18,500	13,000	3,500	18,500	43,000	25,500	7,000	43,000
18,750	13,000	3,500	18,750	44,000	25,500	7,000	44,000
19,000	15,000	4,000	19,000	45,000	25,500	7,000	45,000
19,500	15,000	4,000	19,500	46,000	25,500	7,000	46,000
19,750	15,000	4,000	19,750	47,000	25,500	7,000	47,000
20,000	15,000	4,000	20,000	48,000	25,500	7,000	48,000
20,250	15,000	4,000	20,250	49,000	25,500	7,000	49,000
20,500	15,000	4,000	20,500	50,000	25,500	7,000	50,000
21,000	15,000	4,000	21,000	51,000	25,500	7,000	51,000
21,250	15,000	4,000	21,250	52,000	25,500	7,000	52,000
21,500	15,000	4,000	21,500	53,000	25,500	7,000	53,000
21,750	15,000	4,000	21,750	54,000	25,500	7,000	54,000
22,000	15,000	4,000	22,000	55,000	25,500	7,000	55,000
22,500	15,000	4,000	22,500	56,000	25,500	7,000	56,000



Wechselplatten

d1 mm	l1 mm	b mm	Code-Nr.	d1 mm	l1 mm	b mm	Code-Nr.
57,000	25,500	7,000	57,000	65,000	25,500	7,000	65,000
58,000	25,500	7,000	58,000				
59,000	25,500	7,000	59,000				
60,000	25,500	7,000	60,000				
62,000	25,500	7,000	62,000				
64,000	25,500	7,000	64,000				



Wechselplatten

Artikel-Nr. 86701



P	M	K	N	S	H
●	○	●	○		



Ausspitzung $\geq \varnothing 10,000$ • Wechselplatte ohne Spanteilernuten. Für Werkstoffe bis 600 N/mm^2 . Für universelle Anwendung.
Spitzenwinkel:

$\leq \varnothing 25,4 \text{ mm} = 135^\circ$

$> \varnothing 25,4 \text{ mm} = 132^\circ$

Ohne Fase (siehe „Einsatzempfehlungen Multiplex“/ Technischer Teil)

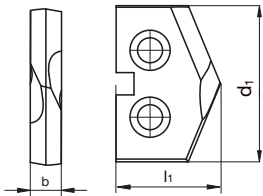

d1 mm	l1 mm	b mm	Code-Nr.	d1 mm	l1 mm	b mm	Code-Nr.
10,000	8,700	2,500	10,000	17,750	11,700	3,500	17,750
10,200	8,700	2,500	10,200	18,000	11,700	3,500	18,000
10,500	8,700	2,500	10,500	18,500	11,700	3,500	18,500
11,000	8,700	2,500	11,000	19,000	13,700	4,000	19,000
11,500	8,700	2,500	11,500	19,500	13,700	4,000	19,500
12,000	8,700	2,500	12,000	20,000	13,700	4,000	20,000
12,500	8,700	2,500	12,500	20,500	13,700	4,000	20,500
12,750	8,700	2,500	12,750	21,000	13,700	4,000	21,000
13,000	8,700	2,500	13,000	21,500	13,700	4,000	21,500
13,500	11,700	3,500	13,500	22,000	13,700	4,000	22,000
13,750	11,700	3,500	13,750	23,000	13,700	4,000	23,000
14,000	11,700	3,500	14,000	24,000	13,700	4,000	24,000
14,250	11,700	3,500	14,250	24,500	13,700	4,000	24,500
14,500	11,700	3,500	14,500	25,000	13,700	4,000	25,000
14,750	11,700	3,500	14,750	26,000	17,300	5,000	26,000
15,000	11,700	3,500	15,000	27,000	17,300	5,000	27,000
15,500	11,700	3,500	15,500	28,000	17,300	5,000	28,000
15,750	11,700	3,500	15,750	29,000	17,300	5,000	29,000
16,000	11,700	3,500	16,000	30,000	17,300	5,000	30,000
16,250	11,700	3,500	16,250	31,000	17,300	5,000	31,000
16,500	11,700	3,500	16,500	32,000	17,300	5,000	32,000
16,750	11,700	3,500	16,750	33,000	17,300	5,000	33,000
17,000	11,700	3,500	17,000	34,000	17,300	5,000	34,000
17,500	11,700	3,500	17,500	35,000	17,300	5,000	35,000



Wechselplatten

Artikel-Nr. 86702



P	M	K	N	S	H
•	○	•	○		



Ausspitzung $\geq \varnothing 10,000$ • Wechselplatte ohne Spanteilernuten. Für Werkstoffe über 600 N/mm². Für universelle Anwendung.
Spitzenwinkel:

$\leq \varnothing 25,4 \text{ mm} = 135^\circ$

$> \varnothing 25,4 \text{ mm} = 132^\circ$

Mit Fase (siehe „Einsatzempfehlungen Multiplex“/ Technischer Teil)

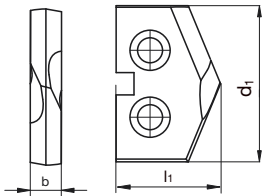

d1 mm	l1 mm	b mm	Code-Nr.	d1 mm	l1 mm	b mm	Code-Nr.
10,000	8,700	2,500	10,000	20,500	13,700	4,000	20,500
10,200	8,700	2,500	10,200	21,000	13,700	4,000	21,000
10,500	8,700	2,500	10,500	21,500	13,700	4,000	21,500
11,000	8,700	2,500	11,000	22,000	13,700	4,000	22,000
12,000	8,700	2,500	12,000	22,300	13,700	4,000	22,300
12,500	8,700	2,500	12,500	22,750	13,700	4,000	22,750
12,750	8,700	2,500	12,750	23,000	13,700	4,000	23,000
13,000	8,700	2,500	13,000	24,250	13,700	4,000	24,250
13,500	11,700	3,500	13,500	24,500	13,700	4,000	24,500
13,750	11,700	3,500	13,750	25,000	13,700	4,000	25,000
14,000	11,700	3,500	14,000	26,000	17,300	5,000	26,000
14,100	11,700	3,500	14,100	26,500	17,300	5,000	26,500
14,500	11,700	3,500	14,500	27,000	17,300	5,000	27,000
14,750	11,700	3,500	14,750	28,000	17,300	5,000	28,000
15,000	11,700	3,500	15,000	29,000	17,300	5,000	29,000
15,500	11,700	3,500	15,500	29,800	17,300	5,000	29,800
16,000	11,700	3,500	16,000	30,000	17,300	5,000	30,000
16,250	11,700	3,500	16,250	32,000	17,300	5,000	32,000
16,500	11,700	3,500	16,500	33,000	17,300	5,000	33,000
16,750	11,700	3,500	16,750	34,000	17,300	5,000	34,000
17,000	11,700	3,500	17,000	35,000	17,300	5,000	35,000
17,500	11,700	3,500	17,500				
17,750	11,700	3,500	17,750				
18,000	11,700	3,500	18,000				
18,250	11,700	3,500	18,250				
18,500	11,700	3,500	18,500				
19,000	13,700	4,000	19,000				
19,500	13,700	4,000	19,500				
19,750	13,700	4,000	19,750				
20,000	13,700	4,000	20,000				



Wechselplatten

Artikel-Nr. 86708



P	M	K	N	S	H
•	○	•	○		



Ausspitzung $\geq \varnothing 9,800$ • Wechselplatte ohne Spanteilernuten. Für Werkstoffe über 600 N/mm². Für universelle Anwendung.
Spitzenwinkel:

$\leq \varnothing 25,4$ mm = 135°

$> \varnothing 25,4$ mm = 132°

Mit Fase (siehe „Einsatzempfehlungen Multiplex“/ Technischer Teil)

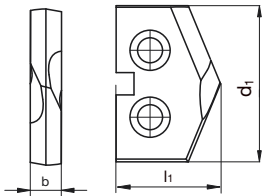

d1 mm	l1 mm	b mm	Code-Nr.	d1 mm	l1 mm	b mm	Code-Nr.
10,000	8,700	2,500	10,000	19,500	13,700	4,000	19,500
10,200	8,700	2,500	10,200	19,750	13,700	4,000	19,750
10,500	8,700	2,500	10,500	20,000	13,700	4,000	20,000
11,000	8,700	2,500	11,000	20,500	13,700	4,000	20,500
11,500	8,700	2,500	11,500	21,000	13,700	4,000	21,000
12,000	8,700	2,500	12,000	21,500	13,700	4,000	21,500
12,250	8,700	2,500	12,250	22,000	13,700	4,000	22,000
12,500	8,700	2,500	12,500	22,500	13,700	4,000	22,500
12,750	8,700	2,500	12,750	22,750	13,700	4,000	22,750
13,000	8,700	2,500	13,000	23,000	13,700	4,000	23,000
13,500	11,700	3,500	13,500	23,500	13,700	4,000	23,500
13,750	11,700	3,500	13,750	24,000	13,700	4,000	24,000
14,000	11,700	3,500	14,000	24,250	13,700	4,000	24,250
14,250	11,700	3,500	14,250	24,500	13,700	4,000	24,500
14,500	11,700	3,500	14,500	25,000	13,700	4,000	25,000
14,750	11,700	3,500	14,750	26,000	17,300	5,000	26,000
15,000	11,700	3,500	15,000	27,000	17,300	5,000	27,000
15,500	11,700	3,500	15,500	28,000	17,300	5,000	28,000
15,750	11,700	3,500	15,750	29,000	17,300	5,000	29,000
16,000	11,700	3,500	16,000	30,000	17,300	5,000	30,000
16,250	11,700	3,500	16,250	31,000	17,300	5,000	31,000
16,500	11,700	3,500	16,500	32,000	17,300	5,000	32,000
16,750	11,700	3,500	16,750	34,000	17,300	5,000	34,000
17,000	11,700	3,500	17,000	35,000	17,300	5,000	35,000
17,500	11,700	3,500	17,500				
17,750	11,700	3,500	17,750				
18,000	11,700	3,500	18,000				
18,250	11,700	3,500	18,250				
18,500	11,700	3,500	18,500				
19,000	13,700	4,000	19,000				



Wechselplatten

Artikel-Nr. 86709



P	M	K	N	S	H
•	○	•	○		

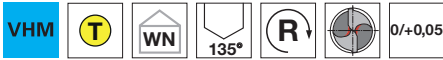

Ausspitzung $\geq \varnothing 9,800$ • Wechselplatte ohne Spanteilernuten. Für Werkstoffe bis 600 N/mm^2 . Für universelle Anwendung.
Spitzenwinkel:

$\leq \varnothing 25,4 \text{ mm} = 135^\circ$

$> \varnothing 25,4 \text{ mm} = 132^\circ$

Ohne Fase (siehe „Einsatzempfehlungen Multiplex“/ Technischer Teil)

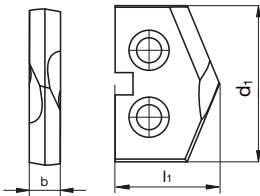

d1 mm	l1 mm	b mm	Code-Nr.	d1 mm	l1 mm	b mm	Code-Nr.
10,000	8,700	2,500	10,000	18,250	11,700	3,500	18,250
10,200	8,700	2,500	10,200	18,500	11,700	3,500	18,500
10,500	8,700	2,500	10,500	19,000	13,700	4,000	19,000
11,000	8,700	2,500	11,000	19,500	13,700	4,000	19,500
11,110	8,700	2,500	11,110	20,000	13,700	4,000	20,000
12,000	8,700	2,500	12,000	20,500	13,700	4,000	20,500
12,500	8,700	2,500	12,500	20,640	13,700	4,000	20,640
12,700	8,700	2,500	12,700	21,000	13,700	4,000	21,000
12,750	8,700	2,500	12,750	21,500	13,700	4,000	21,500
13,000	8,700	2,500	13,000	22,000	13,700	4,000	22,000
13,500	11,700	3,500	13,500	23,000	13,700	4,000	23,000
14,000	11,700	3,500	14,000	23,250	13,700	4,000	23,250
14,500	11,700	3,500	14,500	24,500	13,700	4,000	24,500
14,750	11,700	3,500	14,750	25,000	13,700	4,000	25,000
15,000	11,700	3,500	15,000	26,000	17,300	5,000	26,000
15,880	11,700	3,500	15,880	27,000	17,300	5,000	27,000
16,250	11,700	3,500	16,250	28,000	17,300	5,000	28,000
16,500	11,700	3,500	16,500	29,000	17,300	5,000	29,000
16,670	11,700	3,500	16,670	30,000	17,300	5,000	30,000
16,750	11,700	3,500	16,750	33,000	17,300	5,000	33,000
17,000	11,700	3,500	17,000	34,000	17,300	5,000	34,000
17,500	11,700	3,500	17,500	35,000	17,300	5,000	35,000
17,750	11,700	3,500	17,750				
18,000	11,700	3,500	18,000				



Wechselplatten

Artikel-Nr. 86711



P	M	K	N	S	H
			•		



Ausspitzung $\geq \varnothing 10,000$ • Wechselplatte mit Spanteilemuten. Aluminium-Geometrie für .
 Aluminium-Legierungen, Nichteisenmetalle und Kunststoffe:
 $\leq \varnothing 25,4 \text{ mm} = 135^\circ$
 $> \varnothing 25,4 \text{ mm} = 132^\circ$

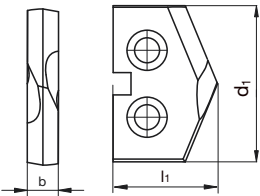

d1 mm	l1 mm	b mm	Code-Nr.	d1 mm	l1 mm	b mm	Code-Nr.
10,000	8,700	2,500	10,000	24,000	13,700	4,000	24,000
10,200	8,700	2,500	10,200	24,250	13,700	4,000	24,250
10,500	8,700	2,500	10,500	24,500	13,700	4,000	24,500
11,000	8,700	2,500	11,000	25,000	13,700	4,000	25,000
11,500	8,700	2,500	11,500	25,400	17,300	5,000	25,400
12,000	8,700	2,500	12,000	26,000	17,300	5,000	26,000
12,250	8,700	2,500	12,250	27,000	17,300	5,000	27,000
12,500	8,700	2,500	12,500	28,000	17,300	5,000	28,000
12,700	8,700	2,500	12,700	29,000	17,300	5,000	29,000
12,750	8,700	2,500	12,750	30,000	17,300	5,000	30,000
13,000	8,700	2,500	13,000	31,000	17,300	5,000	31,000
13,500	11,700	3,500	13,500	32,000	17,300	5,000	32,000
13,750	11,700	3,500	13,750	34,000	17,300	5,000	34,000
14,000	11,700	3,500	14,000	35,000	17,300	5,000	35,000
14,250	11,700	3,500	14,250	36,000	24,000	7,000	36,000
14,500	11,700	3,500	14,500	37,000	24,000	7,000	37,000
14,750	11,700	3,500	14,750	38,000	24,000	7,000	38,000
15,000	11,700	3,500	15,000	39,000	24,000	7,000	39,000
15,500	11,700	3,500	15,500	40,000	24,000	7,000	40,000
15,750	11,700	3,500	15,750	41,000	24,000	7,000	41,000
16,000	11,700	3,500	16,000	42,000	24,000	7,000	42,000
16,250	11,700	3,500	16,250	43,000	24,000	7,000	43,000
16,500	11,700	3,500	16,500	44,000	24,000	7,000	44,000
16,750	11,700	3,500	16,750	45,000	24,000	7,000	45,000
17,000	11,700	3,500	17,000	46,000	24,000	7,000	46,000
17,500	11,700	3,500	17,500	47,000	24,000	7,000	47,000
17,750	11,700	3,500	17,750	48,000	24,000	7,000	48,000
18,000	11,700	3,500	18,000	49,000	24,000	7,000	49,000
18,250	11,700	3,500	18,250	50,000	24,000	7,000	50,000
18,500	11,700	3,500	18,500	51,000	24,000	7,000	51,000
19,000	13,700	4,000	19,000	52,000	24,000	7,000	52,000
19,500	13,700	4,000	19,500	53,000	24,000	7,000	53,000
19,750	13,700	4,000	19,750	54,000	24,000	7,000	54,000
20,000	13,700	4,000	20,000	55,000	24,000	7,000	55,000
20,500	13,700	4,000	20,500	56,000	24,000	7,000	56,000
21,000	13,700	4,000	21,000	57,000	24,000	7,000	57,000
21,500	13,700	4,000	21,500	58,000	24,000	7,000	58,000
22,000	13,700	4,000	22,000	59,000	24,000	7,000	59,000
22,500	13,700	4,000	22,500	60,000	24,000	7,000	60,000
22,750	13,700	4,000	22,750	62,000	24,000	7,000	62,000
23,000	13,700	4,000	23,000	64,000	24,000	7,000	64,000
23,500	13,700	4,000	23,500	65,000	24,000	7,000	65,000

ZUBEHÖR





HARTNER

Kühlmittelzuführringe

Artikel-Nr. 86690



Kühlmittelzuführung für Halter mit MK und Ringlauffläche 86670 und 86680 (ohne Verschraubungsset).

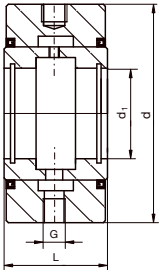

Größe	d1 mm	d mm	G	L mm	Code-Nr.
MK 4	31,750	80,000	G1/4	45,000	31,750
MK 5	63,500	127,000	G1/2	60,000	63,500



Kühlmittelzuführrohre

Artikel-Nr. 82571



Kühlmittelzuführrohr für Kühlmittelzuführringe Artikel-Nr. 86690.

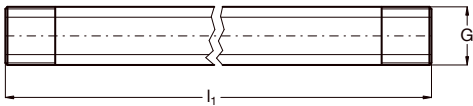

G	l1 mm	Code-Nr.
G1/4	200,000	13,160
G1/2	200,000	20,960



HARTNER

Schnellverschlusskupplung

Artikel-Nr. 82578



Schnellverschlusskupplung für Kühlmittelzuführrohre Artikel-Nr. 82571

G	d3 mm	l1 mm	Code-Nr.
G1/4	9,000	118,000	9,000
G1/2	13,000	118,000	13,000



Torx-Schraubendreher

Artikel-Nr. 86842



Torx-Schraubendreher

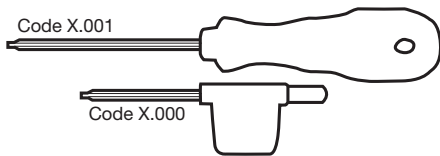

Größe	l1 mm	Code-Nr.
T6	150,000	6,001
T7	150,000	7,001
T8	150,000	8,001
T9	150,000	9,001
T10	170,000	10,001
T15	190,000	15,001
T20	205,000	20,001
T25	207,000	25,001



Klemmschrauben für Wechselplatten

Artikel-Nr. 86807



Torx-Schrauben für Multiplexhalter

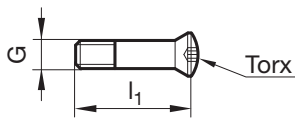

G	l1 mm	Größe	Code-Nr.
M2	4,000	T6	2,000
M 2.5	5,000	T7	2,500
M 2.5	7,000	T7	2,501
M 3	6,000	T9	3,000
M 3	8,000	T9	3,001
M 3.5	10,000	T15	3,500
M 4	6,000	T15	4,000
M 4	15,000	T20	4,001
M 5	20,000	T20	5,000



Kühlmittelzuführfutter für Multiplex

Artikel-Nr. 86691



Kühlmittelzuführfutter mit SK nach DIN ISO 7388-1 und zylindrischer Aufbohrung. Bei kleineren Schaft-Ø Verwendung mit Reduzierhülse.

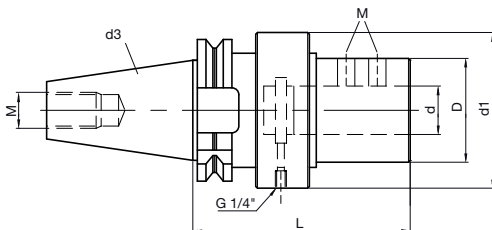

d3	d mm	D mm	d1 mm	L mm	M	Code-Nr.
SK 40	32,000	65,000	88,000	130,000	M16	32,040
SK 50	40,000	65,000	98,000	135,000	M24	40,050
SK 50	50,000	90,000	123,000	165,000	M24	50,050



Kühlmittelzuführfutter für Multiplex

Artikel-Nr. 86692



Kühlmittelzuführfutter mit SK nach DIN 2080 und zylindrischer Aufbohrung. Bei kleineren Schaft-Ø Verwendung mit Reduzierhülse.

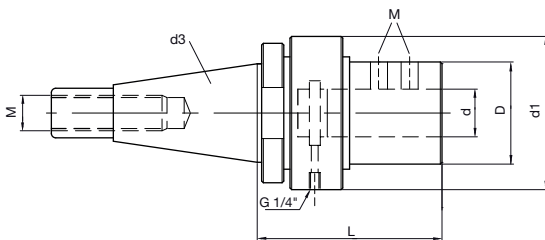

d3	d mm	D mm	d1 mm	L mm	M	Code-Nr.
SK 40	32,000	65,000	88,000	110,000	M16	32,040
SK 50	40,000	65,000	98,000	120,000	M24	40,050
SK 50	50,000	90,000	123,000	145,000	M24	50,050



Kühlmittelzuführfutter für Multiplex

Artikel-Nr. 86693



Kühlmittelzuführfutter mit MK nach DIN 228 B und zylindrischer Aufbohrung. Bei kleineren Schaft-Ø Verwendung mit Reduzierhülse.

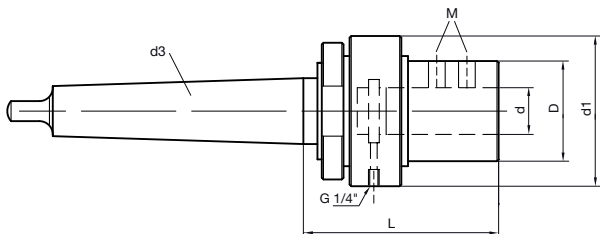

d3	d mm	D mm	d1 mm	L mm	M	Code-Nr.
MK-4	32,000	65,000	88,000	100,000	M14	32,400
MK-5	40,000	75,000	98,000	110,000	M16	40,500
MK-6	40,000	75,000	98,000	120,000	M16	40,600
MK-5	50,000	90,000	123,000	140,000	M20	50,500
MK-6	50,000	90,000	123,000	140,000	M20	50,600



Kühlmittelzuführfutter für Multiplex

Artikel-Nr. 86694



Kühlmittelzuführfutter mit MAS BT nach DIN ISO 7388-2 und zylindrischer Aufbohrung. Bei kleineren Schaft-Ø Verwendung mit Reduzierhülse.

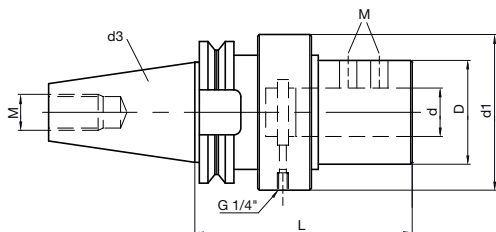

d3	d mm	D mm	d1 mm	L mm	M	Code-Nr.
BT 40	32,000	65,000	88,000	125,000	M16	32,040
BT 50	40,000	65,000	98,000	145,000	M24	40,050
BT 50	50,000	90,000	123,000	170,000	M24	50,050



Reduzierhülsen für Kühlmittelzuführfutter

Artikel-Nr. 86699



Reduzierhülse für Kühlmittelzuführfutter mit zylindrischer Aufnahmebohrung

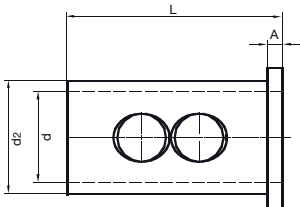

d mm	d2 mm	L mm	A mm	Code-Nr.
20,000	32,000	65,000	5,000	20,032
20,000	40,000	75,000	5,000	20,040
25,000	32,000	65,000	5,000	25,032
25,000	40,000	75,000	5,000	25,040
32,000	40,000	75,000	5,000	32,040

TECHNISCHER TEIL





Die Kühlmittelzuführung

Jeder Multiplex-Halter verfügt über eine innere Kühlmittel-Zufuhr. Sie gewährleistet sowohl beim horizontalen als auch beim vertikalen Bohren eine optimale Kühlmittel- sowie Schmiermittel-Versorgung der Schneiden und verlängert so die Standwege. Gleichzeitig sorgt das Kühlmittel für einen optimierten Späntransport aus der Bohrung heraus. Die Kühlmittel-Zuführung erfolgt bei den verschiedenen Schaftausführungen unterschiedlich:

Zuführbohrung an der Stirnseite des Schaftes

Für **stehende** und **drehende** Werkzeuge:
Kühlmittelzufuhr axial durch die Werkzeugaufnahme.
Für Halter mit Zylinderschaft und Bohr-Ø 10 bis 102 mm.
Halter Art.-Nr. 86612/86622/86624 und überlange Halter.

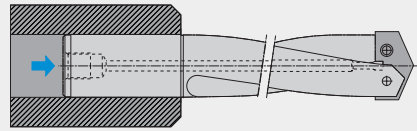

Zuführbohrung an der Stirnseite des Schaftes mit Zuführfutter

Für **drehende** Werkzeuge:
Kühlmittelzufuhr radial durch das Kühlmittelzuführfutter.
Für Halter mit Zylinderschaft und Bohr-Ø 10 bis 102 mm.
Halter Art.-Nr. 86612/86622/86624 und überlange Halter.
Kühlmittelzuführfutter SK40/50 auf zyl. und MK4/5/6 auf zyl.

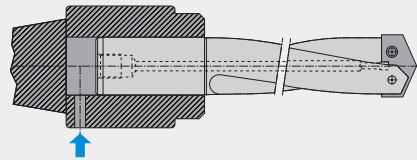

Zuführbohrung am Austreiblappen

Für **stehende** und **drehende** Werkzeuge:
Kühlmittelzufuhr axial durch die Werkzeugaufnahme.
Für Halter mit Morsekegelschaft und Bohr-Ø 10 bis 25 mm.
Halter Art.-Nr. 86630/86650.

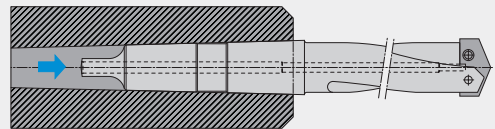

Zuführbohrung seitlich am Morsekegel

Für **stehende** Werkzeuge:
Kühlmittelzufuhr radial durch die Werkzeugaufnahme.
Für Halter mit Morsekegelschaft und Bohr-Ø 10 bis 25 mm.
Halter auf Anfrage.

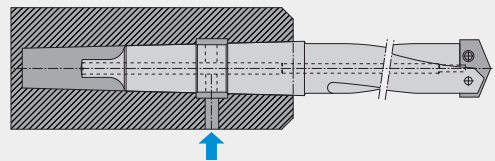

Zuführbohrung seitlich am Sitz der Ringlauffläche

Für **stehende** Werkzeuge:
Kühlmittelzufuhr über direkte Schlauch-/Rohrverbindung mit Gewinde R1/4" und R1/2". Für Halter mit Morsekegel und Sitz für Zuführring für Bohr-Ø 25 bis 102 mm.
Halter Art.-Nr. 86670/86680 und überlange Halter.

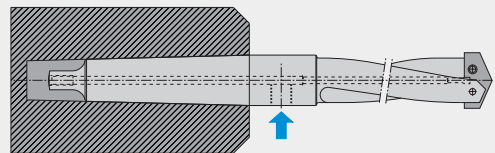

Zuführbohrung seitlich am Sitz der Ringlauffläche

Für **drehende** Werkzeuge:
Kühlmittelzufuhr radial durch den Zuführring.
Für Halter mit Morsekegel und Ringlauffläche ab Bohr-Ø 25 mm.
Halter Art.-Nr. 86670/86680 und überlange Halter.

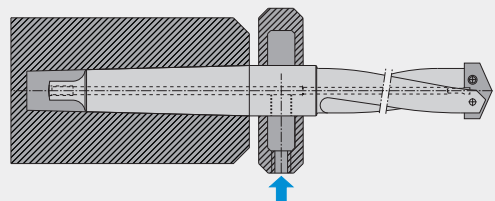



Bohren vorgebohrter Bohrungen

Da das Multiplex System hauptsächlich durch die Querschneide geführt wird, ist es zum Aufbohren von vorgegessenen oder vorgebohrten Löchern nicht geeignet. Falls das System dennoch eingesetzt wird, sind die Einsatzparameter zu verringern.

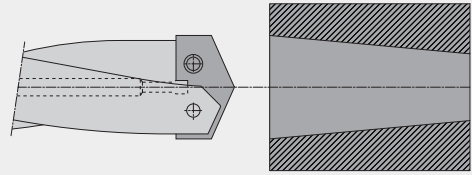

Bohren in unterbrochenem Schnitt

Zum Bohren in unterbrochenem Schnitt (z.B. Querbohrungen, die größer als der Bohrdurchmesser sind) ist das Multiplex System nicht geeignet.

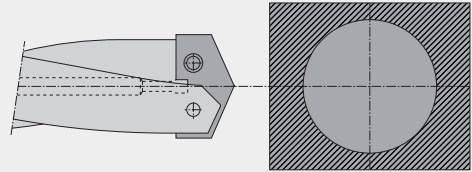

Anzentrieren der Bohrung

Die Bohrplatten des Multiplex-Systems sind ausgespitzt. Ein Anzentrieren ist somit erst ab größeren Bohrtiefen notwendig. Falls das Anzentrieren aus technischen Gründen notwendig ist, muss der Spitzenwinkel der Zentrierung gleich oder größer wie der Spitzenwinkel der Schneidplatte sein.

Dies entspricht: bis $d = 25,4 \text{ mm} = 135^\circ$
bis $d = 66,0 \text{ mm} = 132^\circ$
ab $d = 66,0 \text{ mm} = 140^\circ$

Es kann auch ein kurzer Halter (3xD) zum Anbohren verwendet werden.

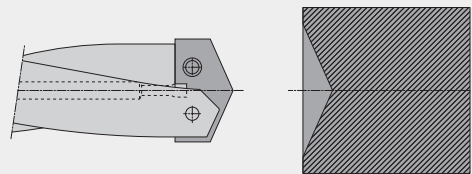

Verlaufen des Bohrers

Ein Verlaufen des Bohrers hängt von verschiedenen Faktoren ab. Als Richtwert für Bohrtiefen bis $7 \times D$ kann man einen Wert von ca. $0,1-0,16 \text{ mm}$ annehmen. In diesem Fall sollte aber immer der kürzest mögliche und somit stabilste Haltertyp verwendet werden.

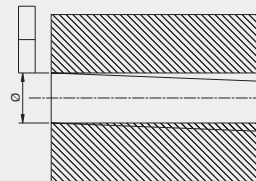

Kühlmitteldruck

Das Kühlschmiermittel ist beim Multiplex System für die Spanabfuhr sehr wichtig. Es kann ab einem Druck von ca. 5 bar betrieben werden. Generell gilt aber: Je mehr Kühlmittel zur Verfügung steht, desto besser. Durch den Einsatz von Kühlmittelringen oder Kühlmittelzuführuttern ist das Multiplex- System auch mit der an älteren Maschinen vorhandenen Außenkühlung einsetzbar. Der jeweilige Anwendungsfall kann jederzeit mit unseren Anwendungstechnikern abgeklärt werden.

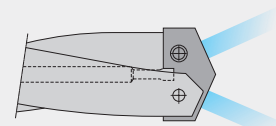

Starker Schneidenverschleiß

Wenn sich an den Schneidecken eine Stufe eingebraunt hat, ist die Schnittgeschwindigkeit zu hoch und muss reduziert werden. Messen Sie den Durchmesser, der abgebrannt ist, und berechnen Sie die Schnittgeschwindigkeit anhand dieses Durchmessers neu. Von dieser neuen Drehzahl ziehen Sie 10% ab und geben diesen Wert dann in die Maschine ein.

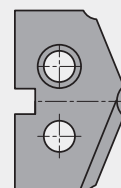



Das Kühlmittelaggregat

Von ganz entscheidender Bedeutung ist ein leistungsfähiges Kühlmittelaggregat. Sind Druck und Menge des Kühlmittels nicht ausreichend, so kann dies zu einer schlechten Bohrungsoberfläche oder zum Werkzeugbruch führen. Die Größe der Feststoffteilchen im Kühlmittel sollten 50 µm möglichst nicht überschreiten.

Als Kühlschmiermittel empfehlen wir beim Einsatz der Multiplex-Werkzeuge sowohl bei Schnellstahl- als auch bei Hartmetall-Wechselplatten Bohremulsion im üblichen Mischungsverhältnis 1 : 20. Wichtiger als die Zusammensetzung der Bohremulsion sind der Kühlmitteldruck und die Kühlmittelmenge. Ein leistungsfähiges Kühlmittelaggregat ist deshalb eine wichtige Voraussetzung für eine ausreichende Kühlung und Schmierung.

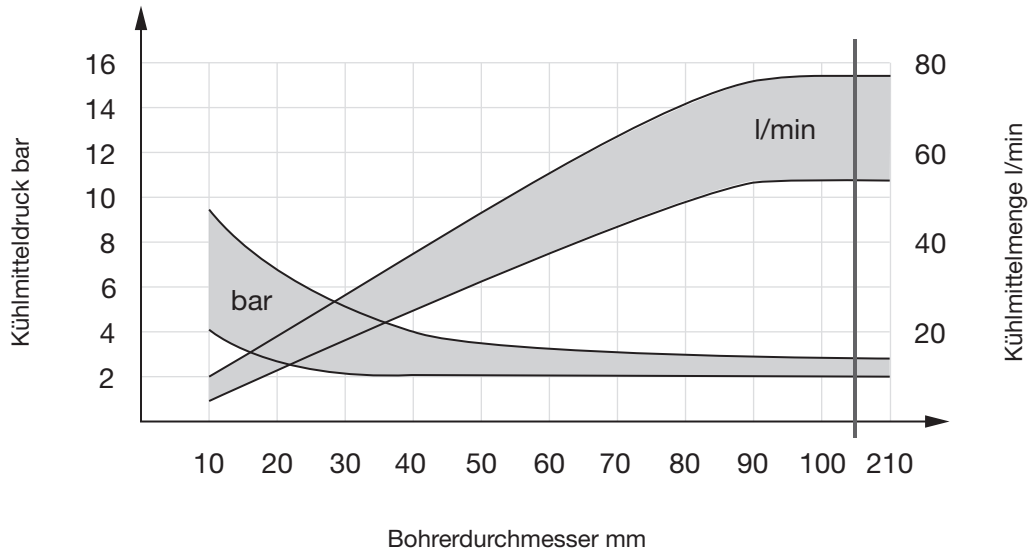

Maschine und Werkstück

Erst die Stabilität von Maschine, Spindel, Werkstückaufspannung und Werkstück ermöglichen den Einsatz des Schneidstoffs Hartmetall. Ungenügende Steifigkeit führt zu Schwingungen oder Durchsacken des Bohrers bei Durchgangslöchern, wenn die Querschneide aus dem Werkstück austritt. Geringe Standwege oder Plattenbruch können die Folge sein.

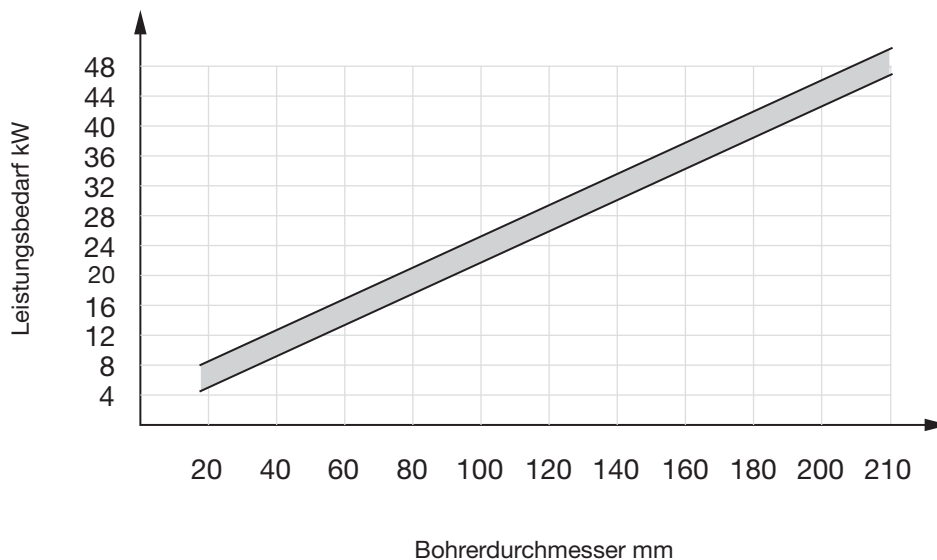



Sondergeometrien



Formplatte* nach Kundenzeichnung
(HSS-E/PM, HSS-E oder HM)



NC-Platte (HSS-E/PM, HSS-E oder HM)
mit 90° oder 120°
(Je nach \varnothing wird der 90°-Winkel im Spitzenbereich verzerrt)



Platte mit Eckenradius
(HSS-E/PM, HSS-E oder HM)



Stufenplatte
(HSS-E/PM, HSS-E oder HM)



Messing-Geometrie (HM)
für den Einsatz in Messing und ähnlichen Werkstoffen



Sacklochplatte* (HSS-E/PM HSS-E)
ohne Zentrierspitze

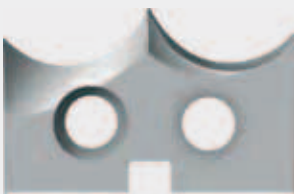

Anschliff für faserverstärkte Kunststoffe (HM)



Radiusplatte* (HSS-E/PM, HSS-E)

*** Beim Einsatz von Formplatten bitte beachten:**

- nur mit kurzem Halter einsetzen
- die Bohrung sollte mit einer normalen Multiplex-Platte vorgebohrt werden (gleicher oder kleinerer \varnothing)
- nur bedingt zum Bohren ins Volle geeignet
- wenn möglich Zeichnungsausschnitt der Bohrung zuschicken

Sondergeometrien erhalten Sie auf Anfrage mit den unterschiedlichsten Beschichtungen aus unserem Programm.
Sprechen Sie uns einfach an. **Lieferzeit ca. 3 Wochen.**

Einsatzempfehlungen Multiplex

Bestell-Nr.
 Ø-Bereich
 Schneidstoff
 Hartmetallsorte
 HM-Anwendungsgruppe
 Oberfläche

Werkzeuge mit fett gedruckter Vorschubreihen-Nr. sind bevorzugt auszuwählen.

Bohrer-Ø mm	Vorschubreihen-Code					
	1	2	3	4	5	6
	f (mm/U)					
10,00	0,08	0,09	0,11	0,14	0,19	0,24
12,50	0,09	0,11	0,13	0,17	0,22	0,28
16,00	0,11	0,13	0,16	0,21	0,27	0,34
20,00	0,13	0,15	0,19	0,25	0,32	0,40
25,00	0,16	0,18	0,23	0,29	0,38	0,48
31,50	0,19	0,22	0,27	0,35	0,45	0,57
40,00	0,23	0,26	0,33	0,42	0,54	0,69
50,00	0,27	0,31	0,39	0,50	0,64	0,82
63,00	0,32	0,38	0,47	0,60	0,77	0,98
102,00	0,40	0,48	0,59	0,74	0,85	1,20
150,00	0,59	0,70	0,87	1,09	1,25	1,76
100,00	0,78	0,93	1,16	1,45	1,67	2,35

Werkstoffbezogene Kühlmittel:

- Luft
- Öl
- Emulsion

Werkstoffgruppe	Werkstoffbeispiele, neue Bezeichnung (in Klammern alte Bezeichnung) Fettgedruckte Zahlen = Werkstoff-Nr. nach DIN EN	Zugfestigkeit MPa (N/mm ²)	Härte	Kühl- mittel
Allgemeine Baustähle	1.0035 S185(St33), 1.0486 P275N(StE285), 1.0345 P235GH(H1), 1.0425 P265GH(H2) 1.0050 E295 (St50-2), 1.0070 E360 (St70-2), 1.8937 P500NH (WStE500)	≤500 ≤1000		○ ○
Automatenstähle	1.0718 11SMnPb30 (9SMnPb28), 1.0736 11SMn37 (9SMn36) 1.0727 46S20 (45S20), 1.0728 (60S20), 1.0757 46SPb20 (45SPb20)	≤850 ≤1000		○ ○
Unlegierte Vergütungsstähle	1.0402 C22, 1.1178 C30E (Ck30) 1.0503 C45, 1.1191 C45E (Ck45) 1.0601 C60, 1.1221 C60E (Ck60)	≤700 ≤850 ≤1000		○ ○ ○
Legierte Vergütungsstähle	1.5131 50MnSi4, 1.7003 38Cr2, 1.7030 28Cr4 1.5710 36NiCr6, 1.7035 41Cr4, 1.7225 42CrMo4	≤1000 ≤1400		○ ○
Unlegierte Einsatzstähle	1.0301 (C10), 1.1121 C10E (Ck10)	≤850		○
Legierte Einsatzstähle	1.7276 10CrMo11, 1.5125 11MnSi6 1.5752 15NiCr13, 1.7131 16MnCr5, 1.7264 20CrMo5	≤1000 ≤1400		● ●
Nitrierstähle	1.8504 34CrAl6 1.8519 31CrMoV9, 1.8550 34CrAlNi7	≤1000 ≤1400		○ ●
Werkzeugstähle	1.1750 C75W, 1.2067 102Cr6, 1.2307 29CrMoV9 1.2080 X210Cr12, 1.2083 X42Cr13, 1.2419 105WCr6, 1.2767 X45NiCrMo4	≤850 ≤1400		○ ●
Schnellarbeitsstähle	1.3243 S 6-5-2-5, 1.3343 S 6-5-2, 1.3344 S 6-5-3	≤1400		●
Federstähle	1.5026 55Si7, 1.7176 55Cr3, 1.8159 51CrV4 (51CrV4)		≤350 HB	●
Gehärtete Stähle	-		≤48 HRC ≤66 HRC	● ●
Rostfreie Stähle, geschwefelt austenitisch martensitisch	1.4005 X12CrS13, 1.4104 X14CrMoS17, 1.4105 X6CrMoS17, 1.4305 X8CrNiS18-9 1.4301 X5CrNi18-10 (V2A), 1.4541 X6CrNiTi18-10, 1.4571 X6CrNiMoTi 17-12-2 (V4A) 1.4057 X20CrNi172 (X17CrNi16-2), 1.4122 X39CrMo17-1, 1.4521 X2CrMoTi18-2	≤900 ≤1100 ≤1500		● ● ●
Gusseisen	0.6010 EN-GJL-100 (GG10), 0.6020 EN-GJL-200 (GG20) 0.6025 EN-GJL-250 (GG25), 0.6035 EN-GJL-350 (GG35)		≤240 HB ≤350 HB	○ ○
Kugelgraphit- und Temperguss	0.7050 EN-GJS-500-7 (GGG50), 0.8035 EN-GJMw-350-4 (GTW35) 0.7070 EN-GJS-700-2 (GGG70), 0.8170 EN-GJMB-700-2 (GTS70)		≤240 HB ≤350 HB	○ ○
Hartguss	-		≤350 HB	○
Neue Gusswerkstoffe GGV	EN-GJV250 (GGV25), EN-GJV350 (GGV35) EN-GJV400 (GGV40), EN-GJV500 (GGV50), SiMo 6		≤220 HB ≤300 HB	○ ○
Neue Gusswerkstoffe ADI	EN-GJS-800-8 (ADI800), EN-GJS-1000-5 (ADI1000) EN-GJS-1200-2 (ADI1200), EN-GJS-1400-1 (ADI1400)	≤1000 ≤1400		○ ○
Sonderlegierungen	Nimonic, Inconel, Monel, Hastelloy	≤2000		●
Titan und Titan-Legierungen	3.7024 Ti99,5, 3.7114 TiAl5Sn2,5, 3.7124 TiCu2 3.7154 TiAl6Zr5, 3.7165 TiAl6V4, 3.7184 TiAl4Mo4Sn2,5, - TiAl8Mo1V1	≤850 ≤1400		● ●
Aluminium und Al-Legierungen	3.0255 Al99,5, 3.2315 AlMgSi1, 3.3515 AlMg1	≤400		○
Al-Knetlegierungen	3.0615 AlMgSiPb, 3.1325 AlCuMg1, 3.3245 AlMg3Si, 3.4365 AlZnMgCu1,5	≤650		○
Al-Gusslegierungen ≤ 10 % Si ≤ 24 % Si	3.2131 G-AlSi5Cu1, 3.2153 G-AlSi7Cu3, 3.2573 G-AlSi9 3.2581 G-AlSi12, 3.2583 G-AlSi12Cu, - G-AlSi12CuNiMg	≤600 ≤600		○ ○
Magnesium-Legierungen	3.5200 MgMn2, 3.5812.05 G-MgAl8Zn1, 3.5612.05 G-MgAl6Zn1	≤400		○
Kupfer, niedriglegiert	2.0070 SE-Cu, 2.1020 CuSn6, 2.1096 G-CuSn5ZnPb	≤500		○
Messing, kurzspanend langspanend	2.0380 CuZn39Pb2, 2.0401 CuZn39Pb3, 2.0410 CuZn43Pb2 2.0250 CuZn20, 2.0280 CuZn33, 2.0332 CuZn37Pb0,5	≤600 ≤600		○ ○
Bronzen, kurzspanend	2.1090 CuSn7ZnPb, 2.1170 CuPb5Sn5, 2.1176 CuPb10Sn 2.0790 CuNi18Zn19Pb	≤600 ≤850		○ ○
Bronzen, langspanend	2.0916 CuAl5, 2.0960 CuAl9Mn, 2.1050 CuSn10 2.0980 CuAl11Ni, 2.1247 CuBe2	≤850 ≤1000		○ ○
Kunststoffe, duroplastisch thermoplastisch	Bakelit, Resopal, Pertinax, Moltopren Plexiglas, Hostalen, Novodur, Makralon	≤150 ≤100		○ ○
aramidfaserverstärkt	Kevlar	≤1000		○
glas-/kohlefaserverstärkt	GFK/CFK	≤1000		○

Einsatzempfehlungen Multiplex

Bestell-Nr.
 Ø-Bereich
 Schneidstoff
 Hartmetallsorte
 HM-Anwendungsgruppe
 Oberfläche

Werkzeuge mit fett gedruckter Vorschubreihen-Nr. sind bevorzugt auszuwählen.

Bohrer-Ø mm	Vorschubreihen-Code					
	1	2	3	4	5	6
	f (mm/U)					
10,00	0,08	0,09	0,11	0,14	0,19	0,24
12,50	0,09	0,11	0,13	0,17	0,22	0,28
16,00	0,11	0,13	0,16	0,21	0,27	0,34
20,00	0,13	0,15	0,19	0,25	0,32	0,40
25,00	0,16	0,18	0,23	0,29	0,38	0,48
31,50	0,19	0,22	0,27	0,35	0,45	0,57
40,00	0,23	0,26	0,33	0,42	0,54	0,69
50,00	0,27	0,31	0,39	0,50	0,64	0,82
63,00	0,32	0,38	0,47	0,60	0,77	0,98
102,00	0,40	0,48	0,59	0,74	0,85	1,20
150,00	0,59	0,70	0,87	1,09	1,25	1,76
100,00	0,78	0,93	1,16	1,45	1,67	2,35

Werkstoffbezogene Kühlmittel:

- Luft
- Öl
- Emulsion

Werkstoffgruppe	Werkstoffbeispiele, neue Bezeichnung (in Klammern alte Bezeichnung) Fettgedruckte Zahlen = Werkstoff-Nr. nach DIN EN	Zugfestigkeit MPa (N/mm ²)	Härte	Kühl- mittel
Allgemeine Baustähle	1.0035 S185(St33), 1.0486 P275N(StE285), 1.0345 P235GH(H1), 1.0425 P265GH(H2) 1.0050 E295 (St50-2), 1.0070 E360 (St70-2), 1.8937 P500NH (WStE500)	≤500 ≤1000		○ ○
Automatenstähle	1.0718 11SMnPb30 (9SMnPb28), 1.0736 11SMn37 (9SMn36) 1.0727 46S20 (45S20), 1.0728 (60S20), 1.0757 46SPb20 (45SPb20)	≤850 ≤1000		○ ○
Unlegierte Vergütungsstähle	1.0402 C22, 1.1178 C30E (Ck30) 1.0503 C45, 1.1191 C45E (Ck45) 1.0601 C60, 1.1221 C60E (Ck60)	≤700 ≤850 ≤1000		○ ○ ○
Legierte Vergütungsstähle	1.5131 50MnSi4, 1.7003 38Cr2, 1.7030 28Cr4 1.5710 36NiCr6, 1.7035 41Cr4, 1.7225 42CrMo4	≤1000 ≤1400		○ ○
Unlegierte Einsatzstähle	1.0301 (C10), 1.1121 C10E (Ck10)	≤850		○
Legierte Einsatzstähle	1.7276 10CrMo11, 1.5125 11MnSi6 1.5752 15NiCr13, 1.7131 16MnCr5, 1.7264 20CrMo5	≤1000 ≤1400		● ●
Nitrierstähle	1.8504 34CrAl6 1.8519 31CrMoV9, 1.8550 34CrAlNi7	≤1000 ≤1400		○ ●
Werkzeugstähle	1.1750 C75W, 1.2067 102Cr6, 1.2307 29CrMoV9 1.2080 X210Cr12, 1.2083 X42Cr13, 1.2419 105WCr6, 1.2767 X45NiCrMo4	≤850 ≤1400		○ ●
Schnellarbeitsstähle	1.3243 S 6-5-2-5, 1.3343 S 6-5-2, 1.3344 S 6-5-3	≤1400		●
Federstähle	1.5026 55Si7, 1.7176 55Cr3, 1.8159 51CrV4 (51CrV4)		≤350 HB	●
Gehärtete Stähle	-		≤48 HRC ≤66 HRC	● ●
Rostfreie Stähle, geschwefelt austenitisch martensitisch	1.4005 X12CrS13, 1.4104 X14CrMoS17, 1.4105 X6CrMoS17, 1.4305 X8CrNiS18-9 1.4301 X5CrNi18-10 (V2A), 1.4541 X6CrNiTi18-10, 1.4571 X6CrNiMoTi 17-12-2 (V4A) 1.4057 X20CrNi172 (X17CrNi16-2), 1.4122 X39CrMo17-1, 1.4521 X2CrMoTi18-2	≤900 ≤1100 ≤1500		● ● ●
Gusseisen	0.6010 EN-GJL-100 (GG10), 0.6020 EN-GJL-200 (GG20) 0.6025 EN-GJL-250 (GG25), 0.6035 EN-GJL-350 (GG35)		≤240 HB ≤350 HB	○ ○
Kugelgraphit- und Temperguss	0.7050 EN-GJS-500-7 (GGG50), 0.8035 EN-GJMw-350-4 (GTW35) 0.7070 EN-GJS-700-2 (GGG70), 0.8170 EN-GJMB-700-2 (GTS70)		≤240 HB ≤350 HB	○ ○
Hartguss	-		≤350 HB	○
Neue Gusswerkstoffe GGV	EN-GJV250 (GGV25), EN-GJV350 (GGV35) EN-GJV400 (GGV40), EN-GJV500 (GGV50), SiMo 6		≤220 HB ≤300 HB	○ ○
Neue Gusswerkstoffe ADI	EN-GJS-800-8 (ADI800), EN-GJS-1000-5 (ADI1000) EN-GJS-1200-2 (ADI1200), EN-GJS-1400-1 (ADI1400)	≤1000 ≤1400		○ ○
Sonderlegierungen	Nimonic, Inconel, Monel, Hastelloy	≤2000		●
Titan und Titan-Legierungen	3.7024 Ti99,5, 3.7114 TiAl5Sn2,5, 3.7124 TiCu2 3.7154 TiAl6Zr5, 3.7165 TiAl6V4, 3.7184 TiAl4Mo4Sn2,5, - TiAl8Mo1V1	≤850 ≤1400		● ●
Aluminium und Al-Legierungen	3.0255 Al99,5, 3.2315 AlMgSi1, 3.3515 AlMg1	≤400		○
Al-Knetlegierungen	3.0615 AlMgSiPb, 3.1325 AlCuMg1, 3.3245 AlMg3Si, 3.4365 AlZnMgCu1,5	≤650		○
Al-Gusslegierungen ≤ 10 % Si ≤ 24 % Si	3.2131 G-AlSi5Cu1, 3.2153 G-AlSi7Cu3, 3.2573 G-AlSi9 3.2581 G-AlSi12, 3.2583 G-AlSi12Cu, - G-AlSi12CuNiMg	≤600 ≤600		○ ○
Magnesium-Legierungen	3.5200 MgMn2, 3.5812.05 G-MgAl8Zn1, 3.5612.05 G-MgAl6Zn1	≤400		○
Kupfer, niedriglegiert	2.0070 SE-Cu, 2.1020 CuSn6, 2.1096 G-CuSn5ZnPb	≤500		○
Messing, kurzspanend langspanend	2.0380 CuZn39Pb2, 2.0401 CuZn39Pb3, 2.0410 CuZn43Pb2 2.0250 CuZn20, 2.0280 CuZn33, 2.0332 CuZn37Pb0,5	≤600 ≤600		○ ○
Bronzen, kurzspanend	2.1090 CuSn7ZnPb, 2.1170 CuPb5Sn5, 2.1176 CuPb10Sn 2.0790 CuNi18Zn19Pb	≤600 ≤850		○ ○
Bronzen, langspanend	2.0916 CuAl5, 2.0960 CuAl9Mn, 2.1050 CuSn10 2.0980 CuAl11Ni, 2.1247 CuBe2	≤850 ≤1000		○ ○
Kunststoffe, duroplastisch thermoplastisch	Bakelit, Resopal, Pertinax, Moltopren Plexiglas, Hostalen, Novodur, Makralon	≤150 ≤100		○ ○
aramidfaserverstärkt	Kevlar	≤1000		○
glas-/kohlefaserverstärkt	GFK/CFK	≤1000		○



HARTNER

86708	86709
10...35	10...35
VHM	VHM
H22	H22
K20/K40	K20/K40
T	T

86701	86702
10...35	10...35
VHM	VHM
H22	H22
K20/K40	K20/K40
F	F

86711
10 - 65
VHM
H22
K20/K40
○

Art.-Nr. 86709/86701**ohne Fasen**für Werkstoffe bis
ca. 600 N/mm²
Zugfestigkeit**Art.-Nr. 86708/86702****mit Fasen**für Werkstoffe ab
ca. 600 N/mm²
Zugfestigkeit

v _c m/min	Vorschubreihen-Code
60	5
55	4
100	4
95	4
80	4
80	4
75	3
70	4
60	3
85	4
70	4
55	3
60	3
50	2
40	3
35	2
40	2
35	2
25	1
40	2
25	2
100	5
90	4
80	4
65	3
25	1
180	5
160	5
140	5
130	5
150	5
70	4
160	5
110	4
80	5
65	4
45	4
35	4
70	3
70	3
70	3
70	3

v _c m/min	Vorschubreihen-Code
70	5
65	4
115	4
105	4
90	4
90	4
85	3
80	4
70	3
95	4
80	4
65	3
65	3
55	2
45	3
40	2
45	2
40	2
30	1
45	2
30	2
120	5
105	4
90	4
75	3
30	1
180	5
160	5
140	5
130	5
150	4
70	5
160	4
110	5
80	4
65	4
45	4
35	4
70	3
70	3
70	3
70	3

v _c m/min	Vorschubreihen-Code
180	5
160	5
140	5
130	5
150	4
70	5
160	4
110	5
80	4
65	4
45	4
35	4
70	3
70	3
70	3
70	3



Spitzenwinkel bei Plattendurchmesser

- ≤ Ø 25,4 = 135°
- > Ø 25,4 = 132°
- > Ø 66,0 = 140°
- > Ø 190,0 = 150°

Mit Schleppfase bei HM-Platten Ø 10,0 - 35 mm und bei HSS-E-PM Platten Ø 10,0 - 25,4 mm

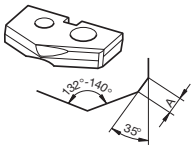

Bohrdurchmesser	Schleppfase A
Ø 10,0 - 13,4	0,25 ±0,05
Ø 13,5 - 18,9	0,30 ±0,05
Ø 19,0 - 25,4	0,35 ±0,05
Ø 25,5 - 35,0	0,40 ±0,05

Bitte beachten Sie:

Da die Multiplex-Werkzeuge vorwiegend durch die Querschnide geführt werden, sind sie zum Aufbohren von vorgegossenen oder vorgebohrten Löchern nicht geeignet!

Details finden Sie im Kapitel "Tipps und Tricks" auf S. 24

Die Wechselplatte 86609 aus PM-Stahl

Die Platte mit optimierter Geometrie und spezieller AlTiN-Beschichtung.

Für verbesserte Spanbildung, höhere Standzeiten und reduzierten Verschleiß.

Die V-förmigen Spanteiler vermindern das Verkleben von Spänen und erhöhen somit die Lebensdauer des Werkzeugs.

Anwendungsbereiche:

Stahl, Guss, hochwärmefeste Legierungen

Vorteile:

- verbesserte Spanbildung
- erhöhte Standzeit (durch die Eckenfase) und verringerte Ausbrüche bzw. verringerte Gratbildung beim Durchbohren
- durch Eckenfase verbesserte Wärmeabfuhr und reduzierter Verschleiß
- durch das neue pulvermetallurgische HSS-E (≤ Ø 66,0 mm, > Ø 66,0 mm HSS-E) sind höhere Schnittgeschwindigkeiten und Standzeiten erreichbar

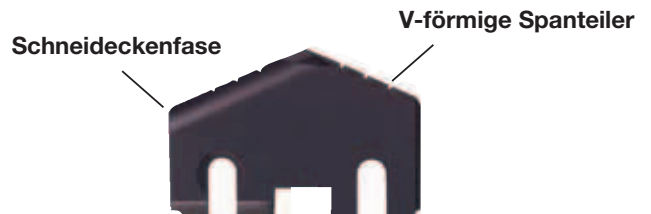

ISO-Code

P	Stahl, hochlegierter Stahl
M	Rostfreier Stahl
K	Grauguss, Sphäroguss und Temperguss
N	Aluminium und andere Nichteisenmetalle
S	Sonder-, Super- und Titanlegierungen
H	Gehärteter Stahl und Hartguss

Piktogramme

Schneidstoff	VHM Vollhartmetall	HSS-E-PM Schnellstahl	HSS-E				
Oberfläche	AITiN	blank	brüniert	dampf-behandelt	FIRE	vernickelt	TiN
Bohrtiefe	3xD	5xD	7xD				
Norm	nach Hartner Standard						
Spitzenwinkel	132°	135°	180°				
Schaftform	nach DIN 6535	zylindrisch	Morsekegel	Steilkegel	MAS-BT		
Ausspitzung	mit Ausspitzung						
Schneidrichtung	rechts	links					
Innenkühlung	mit IK	ohne IK					



DAS HARTNER PROGRAMM



▼ FU 500 / FN 500



▼ TIEFLOCHBOHRER



▼ INOX-BOHRER



▼ KLEINSTBOHRER



▼ GEWINDEWERKZEUGE



▼ TS-DRILLS



▼ TF 100 MULTI-MILL



▼ VHM-FRÄSWERKZEUGE



▼ FASFRÄSER



▼ MULTIPLEX



▼ MULTIPLEX HPC



▼ TM-WERKZEUG-
AUSGABESYSTEME



Schnyder + Minder AG
Zielmattenring 11
5H-4563 Gerlafingen
Phone: +41 31 832 77 00
info@smttools.ch

www.smttools.ch